



OCLI Antireflection Coatings Improve the View...nearly everywhere.

It all started with a need to reduce the glare from aircraft instrument covers. Working closely with the U.S. Air Force, OCLI designed and developed a multilayer state-of-the-art coating that reduced reflections five times better than a single layer of MgF_2 . For several years now pilots have been able to read their instruments with ease through covers

coated by OCLI and our licensees. A most satisfying development, but that was only the beginning. Today descendants of that coating, each modified to do a specific job, are improving the view in a lot of places. If you are having trouble with reflections, ghost images, poor visibility, we can probably help you. If yours is a stubborn problem and you

let us in at the beginning, chances are you'll benefit from working with our research scientists and design engineers. Try us. We supply more than just a product.

OCLI OPTICAL COATING LABORATORY, INC.
Technical Products Division
2789 Giffen Ave., P.O. Box 1599, Santa Rosa, CA 95403
Teletype 510-744-2083. Telephone 707-545-6440.

Manufacturing facilities serving Europe, OCLI Optical Coatings, Ltd., Dunfermline, Fife, Scotland / Represented in Japan by Hakuto Co., Ltd., Tokyo; France, Belgium, Netherlands and Luxembourg by Techmaton of Paris, Brussels & Amsterdam; and in Germany, Austria, Switzerland and Italy by Betzelt GMBH, Munich.

Circle #6 on Readers Service Card

SID JOURNAL

The Official Journal of the Society For Information Display
Formerly INFORMATION DISPLAY JOURNAL

EX Bernard J. Lechner
RCA Laboratories
Princeton, N.J. 08540

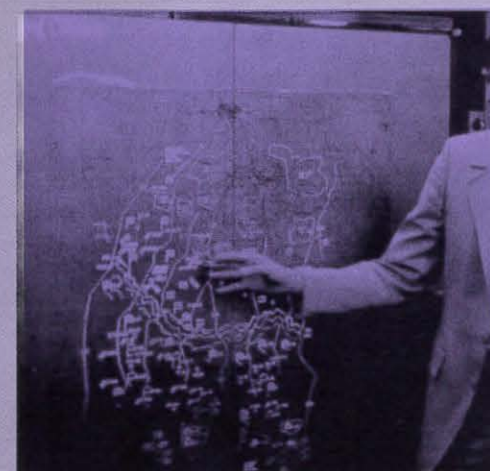
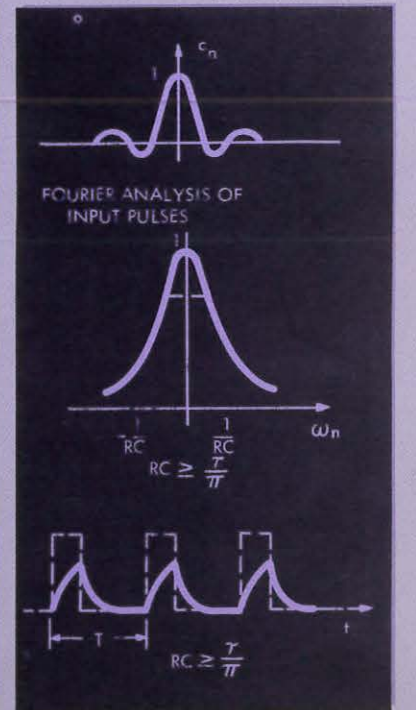
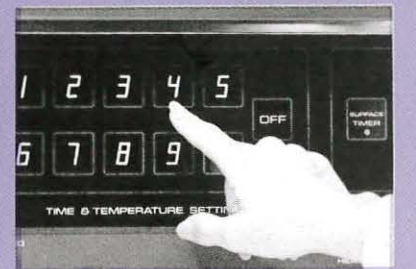
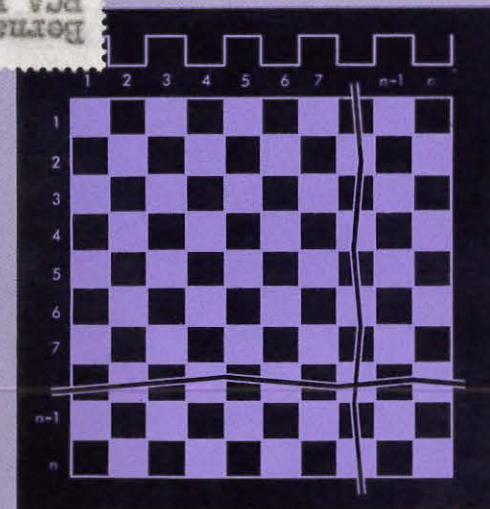

Data Communications Revolution Trends In Terminal-to-Computer Communications

By L. W. HILL

A Disc-Based Multiple Terminal Display System

By A. M. HLADY

Properties of Resonant Scan Monitors For An Alphanumeric Display

By ROBERT W. WHITNEY

The Impersonal Benefit

By WILLIAM CARSON

REVOLUTION

vol. 10, Number 6

Nov./Dec. - 1973



syntronic - yoke specialists

Complete Line for every Industrial & Military Display ... in Production • Phone 312, 543-6444
Quantities ... or Custom Designed to your specific requirement. • TWX 910-651-2191



Selection of the proper yoke involves consideration of many interacting factors: the display system, the CRT, and the circuitry. To help you make the best choice for your application ask for free Yoke Selection and Application Check List.

SYNTRONIC INSTRUMENTS, INC.
100 Industrial Road, Addison, IL 60101
Phone: 312, 543-6444

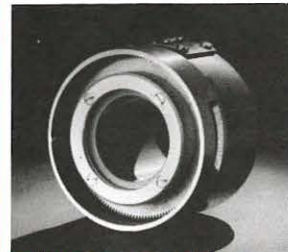

COMPACT ROTATING YOKES

Designed for Radar PPI's and other rotating applications. Up to 52° and 70° deflection angles. Versions available with d-c off-centering coils. Unit complete in aluminum housing with coil, slip rings and brush assembly, drive gear and bearing. Only 3 3/4" OD x 2 1/8" long; for 1 1/2" neck diameter tubes. For technical details request catalog page on Y25 series.



PRECISION STATOR YOKES FOR 1 1/2" TUBES

Designed for the high resolution required for character displays, time shared sweep displays, flying spot scanners etc. Laminated core provides exceptionally low astigmatism and only 0.05% residual magnetism. Push-pull or single-ended coils in a selection of impedances to match your circuit. For technical details request catalog page Y58 series.



HIGH-Q DEFLECTION YOKES FOR 1 1/2" TUBES

Developed for high speed random positioning and alpha-numeric displays where fast settling and high stroke speeds are essential. The ferrite core virtually eliminates core time constant. Beam settling is less than 2 usec. Available with push-pull or single-ended coils in a variety of impedances to match transistor drives. For technical data request catalog page on Y68 series.



MINIATURE 1" ID ENCAPSULATED YOKES

Laminated core design ideal for small neck CRTs, airborne displays, small scan converters, flood gun storage tubes etc., in both single-ended and push-pull coil configurations. High efficiency. Wide range of impedances. Precise construction for close geometrical tolerances. Low residual magnetism. Fast recovery. Weight: only 7 oz. For technical details see catalog page on Y65 series.



MINIATURE FERRITE CORE YOKES

Close geometrical tolerances, high stroke speeds and fast settling for small alpha-numeric displays, random position displays, etc. are achieved with this 1" neck dia. ferrite core yoke. Push-pull and single-ended coils available in a wide range of impedances for transistor or vacuum tube circuits. For full technical details see catalog page C7400.

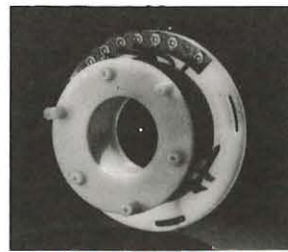

CHARACTER WRITING YOKES

Popular high-frequency "diddle" yokes provide low-cost method of producing alpha-numeric characters for computer readout displays. Mount directly on rear of Series Y58 and Series Y68 yokes which are used to position characters on CRT screen. For electrical and mechanical characteristics see catalog page on C5903/C5904 series.



SHIELDED PRECISION FOCUS COILS

Designed for precision applications where high resolution is required over the entire useful area of the CRT face. Static and dynamic coils combine into a single gap to ease alignment and positioning. Gap in forward location for superior focus and best image-to-object ratio. For technical details see catalog sheet on type F55 series.

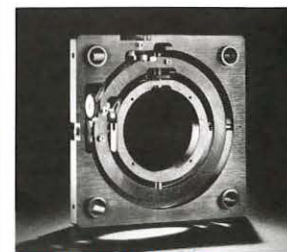

MICROPOSITIONER COIL/LENS ALIGNER

New low cost micropositioner for deflection yokes and focus coils or for optical bench applications provides minimum backlash fine adjustments for pitch, yaw, horizontal and vertical translation. Positive locks for all four independent adjustments make it easy to change one adjustment without disturbing others. Available from stock, Models D 7450 and D 7675.

Circle #1 on Readers Service Card

SID JOURNAL

The Official Journal of the Society For Information Display

Data Communications Revolution Trends In Terminal-to-Computer Communications

5 By L. W. HILL

Interesting communications situations impacting the display of information, emphasizing the geopolitical as well as the technical.

A Disc-Based Multiple Terminal Display System

9 By A. M. HLADY

A disc memory for refresh storage.

Properties of Resonant Scan Monitors For An Alphanumeric Display

14 By ROBERT W. WHITNEY

A description of the role, performance and evolution of the resonant scan monitor in the display of dot matrix alphanumeric in the peripheral computer terminal.

ID Application on GM and Frigidaire Range

21

The Impersonal Benefit

23 By WILLIAM CARSON

Some extraordinary CRT applications which appear to enhance the value of such devices to society at large; and to overcome some of the general public's mistrust of computing engines.

President's Message 4

New Products 25

Sustaining Members 30

Advertiser's Index 30

table of contents

CLOSING DATES: Editorial closing date is the first of the month preceding month of issue. Advertising closing date is the 15th of the month preceding date of issue.
SUBSCRIPTIONS: U.S., its territories and Canada \$10.00 per year. \$18.00 for 2 years. Foreign Countries \$20.00 per year.
EDITORIAL CONTRIBUTIONS: All material must be accompanied by stamped return envelopes. While all reasonable care will be taken with editorial submissions the publisher assumes no responsibility for art work, manuscripts or photographs.
Copyright 1972 by The Society for Information Display.
Controlled circulation postage paid at Los Angeles, California.

THE OFFICIAL JOURNAL OF THE SOCIETY FOR INFORMATION DISPLAY. Published bimonthly by Blackwell Publishing Company, 1605 Cahuenga Boulevard, Los Angeles, California 90028, 213/463-4891. Correspondence regarding advertising, reprints and subscriptions should be sent to the above address.

Publisher, Robert Black/**Editor,** Erwin A. Ulbrich/**Editorial Coordinator,** Roby Wentz/**Advertising Manager,** William R. Brand/**Production Manager,** Joyce Wallace/**Circulation Manager,** S. Rocklin.

SID NATIONAL OFFICERS: President, Dr. Carlo P. Crocetti/**Vice President,** Robert C. Klein/**Secretary,** Erwin A. Ulbrich/**Treasurer,** B. J. Lechner.

National Office Manager . . . Violet Puff

vol. 10, number 6

nov./dec. 1973



measures light as
the eye sees it!



See-through,
non-polarizing
optical system

NEW

SPECTRA® SPOTMETER™

PORTABLE, SELF-CONTAINED, SOLID
STATE DIGITAL PHOTOMETER

For ACCURATE LIGHT MEASUREMENTS!

- LUMINANCE
- ILLUMINANCE
- RADIANCE
- IRRADIANCE
- COLOR TEMPERATURE

For APPLIED PHOTOMETRY in...

- AERO-SPACE . . . SCIENCE
- INFORMATION DISPLAY
- MEDICINE . . . PSYCHOLOGY
- HUMAN FACTORS
- VISION RESEARCH

Write or call collect (213) 849-6017 for
data sheets, application notes or engi-
neering assistance.

PHOTO RESEARCH

A Division of KOLLMORGEN Corporation
3000 N. Hollywood Wy., Burbank, CA 91505

Circle #2 on Readers Service Card

EDITOR'S MESSAGE PRESIDENT'S MESSAGE

Much of the emphasis of the Society has been on display of information on all types of hardware. Very little emphasis has been given to where this information comes from or how it gets to this display. The intention of this special issue is, at least partially, to place more emphasis on communication between displays.

Hopefully, to anyone who has had telephone problems while hooking up a display, Mr. Hill's article on the data communication revolution will strike a familiar chord. The possibilities associated with displays refreshed from video discs is covered in Mr. Hlady's article, while some of the methods of test and evaluation of resonant scan monitors are covered in Mr. Whitney's contribution.

Mr. Carson's article on the use of terminals by three classes of people not usually thought of as computer users reminds us of the expansion that is possible if we can solve the communications and software problems.

Most market research analyses these days show great growth in the telecommunications area. This is especially true in those areas where savings of energy are involved, such as teleconferencing. Coincident with the growth of this market will be a growth of the display terminal market. In many instances the two markets will be hard to differentiate. The recent court decisions on value-added networks is an example of a situation in which it is hard clearly to delineate the telecommunications from the terminals, and from the value added by the software. We hope in future to further extend the content of the JOURNAL into these areas.

In 1974, we plan to publish six issues of the JOURNAL. At this time it is intended that these six will cover the general areas of: information display architecture; special CRTs; display languages; charge-coupled devices; large displays; and liquid crystals. We will also review those papers submitted for the International Symposium, looking closely for topical, non-archival papers of interest. In addition, any and all papers which the readers of this JOURNAL care to submit will be carefully reviewed—ERWIN A. ULBRICH, Editor, SID JOURNAL, 7739 Elden Avenue, Whittier CA, 90602.

EDITORIAL BOARD: Chairman, Erwin A. Ulbrich, McDonnell-Douglas Astronautics/Thomas V. Curran, Information Displays, Inc./ George Kaelin, Litton Industries, Inc./ Violet Puff, Society for Information Display/A. H. Wisdom, TRW Systems Group.
SID National Headquarters/654 N. Sepulveda/Los Angeles, Calif. 90049/Tel. 213/472-3550

OARDA COMMUNICATIONS REVOLUTION TRENDS

BY L. W. HILL
McDonnell Douglas
Automation Company

In Terminal -to- Computer Communications

Interesting communications situations impacting the display of information, emphasizing the geopolitical as well as the technical.

■ Paul S. Rees in his book "Don't Sleep Through the Revolution" remarks about Rip Van Winkle coming back after 20 years with tattered clothes and rusty gun to find he has slept through the Revolution. We are now in the middle of a data communications revolution. I hope to open your eyes to where we are and where we will be in the communications revolution. In order to hit some of the high points, it is necessary to discuss many items briefly.

It was not too many years ago that large computers had card readers, printers, typewriters and other peripheral devices scattered around the computer room. Peripheral devices are still there, but they are also located at remote locations where they are called terminals. They are connected to large central computers by use of communications links. A typical remote job

entry terminal includes a card reader to input data to the computer and a printer to receive output data from the computer. A formatting and buffering unit prepares data for serial transmission to the telephone line. A modem supplied by the telephone company, or other supplier, converts the digital signal to analog format for transmission over the telephone line. This conversion is called modulation. At the other end of the telephone line, the analog signal is demodulated and converted back to digital format in another modem. IBM punched card data is then read from the terminal card reader and transmitted to the computer. After processing in the computer, data is sent back again to the terminal for printing.

Terminals, modems, and telephone lines have been around for a few years. What caused the sudden and dramatic growth in the number of terminals? First, large computers provide lower cost data processing on a per calculation basis than smaller computers. Smaller computers anywhere can be replaced with a terminal and communications equipment. For example,

EDITOR'S NOTE: This article on the revolution in data communication between terminals was originally presented at a Technical Meeting of the AIAA.

a Los Angeles company has replaced its computer in Europe with a terminal, an undersea cable, and a leased telephone line to a central computer. The cost of the terminal, telephone communications equipment, and a share of the Los Angeles computer are less than the cost of the small computer replaced in Europe.

Second, large computers have the capability of storing large data files. When large costly files are repeated at many computer locations, the total cost is higher and it is necessary to duplicate and update the storage at each location. Our company keeps a centralized file for aircraft spare parts. Airlines all over the world interface to this one centralized file. Imagine the problems and costs if these files were duplicated on a world-wide basis.

Software Packages Can Be Shared

Third, large centralized computers have large on-line and off-line memories needed to solve special problems. In California it is necessary to submit large building designs and petrochemical plant designs for earthquake analysis before construction can start. For those of you who have designed large indeterminate structures, you know the magnitude of dynamic stress calculations that can be associated with an earthquake shock and vibration analysis. Our company typically makes these large calculations at night when several million bytes of core storage are available for the lengthy calculations. Smaller computers are inadequate for the application. In another application, smaller consulting civil engineering companies have inexpensive teletypewriters. These small teletypewriters can enter data into the largest commercial computer IBM supplies, the 370/195. Up to four million bytes of core storage are available for data processing, yet the output may be supplied back to the inexpensive teletypewriters or local page printer. The power of the largest computer becomes available to the smallest user. Charges only apply when the large computer is used.

Fourth, large computers can hold specialized software packages that can be shared by a number of users. Users share the cost of program development by paying a small surcharge on top of the processing cost. Did you ever think of the number of duplicate or similar programs developed in different companies? I am sure that in this room there are several who have developed their own programs for the analysis of shock, vibrations, and dynamic stress in aircraft and missile systems. It saves time and money to use programs that are shared with others.

Let's look at an example of a revolutionary change that is occurring in hospital data processing. Data processing is not the major function of hospitals any more than it is the major function for companies represented in this room. Some hospitals have good data processing and some have fair to poor data processing. What is poor data processing? When the patient

leaves the hospital, his bill should be accurate and reflect all charges. If charges come after the patient has left, that is poor data processing. With this there is a major bill collection problem. Our company, in looking over the hospital data processing field, found an excellent operation in a group of hospitals in Peoria, Illinois. Today, a few years later, this computer center has been expanded to serve 139 hospitals in 23 states. Most of these hospitals tie into the center using terminal and telephone communications equipment. The computer programs cover hospital accounting and patient care. Each hospital shares in the cost for the computer and development of computer programs. What I have just described for hospitals also applies for automobile dealers, credit unions, school districts, civil engineering companies, land developers, and many others.

Are there trends that affect the rate of growth? Let's look at costs. Each year the computer manufacturers bring out new and improved models. The manufacturers try to upgrade the users by leasing them more powerful computers at a slightly higher price. While the total cost increases, the cost per calculation or character stored decreases. With many users sharing a central computer, the hardware costs provided per user operation decrease. Occasionally, there is a design improvement or competitive condition that leads to a cost reduction. As an example, IBM recently brought out a new 3705 communications controller to replace their earlier 2701, 2702, and 2703 models. In most cases the 3705 lease price paid by the user is less than the previous lease price with no change in equipment capability. In another example, the telephone companies in California have replaced their older 203A modem costing \$220 per month with the newer 208 modem costing \$100 per month. In the remote job entry terminal field, the IBM 2780 is still dominant; but in many cases, the terminal has been replaced with a competitive unit at about 20 percent lower monthly rental. In addition, newer terminals operating at up to four times faster, with greater capability, only cost 50 percent more per month.

Effect of Reduced Phone Line Costs

What has happened to telephone line costs? Generally, there has been a slight increase due to increased labor costs. In California we have an unusual situation in which the State Public Utility Commission has objected to telephone company accounting practices and has ordered Pacific Telephone to refund the difference to users, so there are lower rates. But line costs are not the only factor affecting data communications costs. Many leased lines were initially installed to transmit data at 2400 bits per second. With no change in line characteristics, the data rates have been increased to as high as 9600 bits per second. This means the cost per character transmitted has dropped drastically.

All of these cost reductions have led to an increased number of terminals being connected to a central computer. In a few short years, one of our large computers that was initially handling data from a centralized

location is now primarily handling remote data from terminals.

The Future: Picturephone Terminals

A recent "Institute of the Future" survey has projected the telecommunications future for 1985, based upon the response of some 210 industry experts. One of the big terminal areas listed was Picturephone terminals. Note that this projection is based upon industry experts and not upon the telephone companies who supply the Picturephone terminal and telephone service. The Bell Laboratories assigned one of their Picturephone data communications studies to the Illinois Bell Telephone Company. This study involved the interface of the Picturephone to a large computer. McDonnell Douglas Automation in St. Louis was selected to provide the IBM computer, the IMS data base, the special interface equipment, and special interface software. In the study, the terminal service was directed towards the medical center application where patient records are accessed from the data base and displayed on the Picturephone. The telephone equipment was configured for transmission at a medium data rate of 1200 bits per second. The Picturephone screen holds 20 lines of data with 22 characters per line. Note that the picture part of the Picturephone requires much higher data rates when not used to access the computer. Technically, the test was successful but marketing is a future problem.

Along with the technical and operational evaluation there was a survey made in St. Louis to establish customer interest. Eighty-six percent of the respondents showed an interest in computer data transmission. The survey also showed that the cost per unit per month was ranked as the factor that is most likely to affect the respondents' decision to install Picturephone service. Due to the large telephone expansion required to set up a community Picturephone network, there appears to be a reluctance on the part of the telephone companies to decide to go ahead. Telephone expansion for Picturephone video transmission is very expensive. Note that at present, data communications is only an extra feature on the total Picturephone service, and not a competitive stand-alone offering.

What can we expect in the future? For many applications the long distance leased telephone line costs are still one of the major costs. How will satellite communication change this? The Federal Communications Commission has established an open-sky policy towards satellite communications—with one exception. The Bell Telephone System can compete with other



about the author

Lewis W. Hill is a Staff Specialist in the Computer Communications Systems—West Department of McDonnell Douglas Automation Company, Long Beach, California. His current areas of activity include communications terminals, data communications systems and long range planning. Mr. Hill received his B.S. in M.E. from Lehigh University and MME from Rensselaer Polytechnic Institute. He has over twenty years experience in Electrical Engineering in computers and communications. He is a member of the Institute of Electrical and Electronic Engineers, Computer Society and Telecommunications Association.

suppliers after three years of operation. This permits the new suppliers to service the large users before "Ma Bell" service becomes dominant. Western Union has been granted permission from the FCC to build their satellite, and it is scheduled to be operational by the middle of 1974. American Satellite is expected to beat them by leasing service from the Canadian satellite. This service is expected to be available in 1973. Long distance communications costs in the United States will no longer be related to distances along the surface of the earth. It is possible, in one satellite, to build enough transponders to handle 24 broad area TV channels and 57,000 full duplex telephone channels. When the satellite antenna uses a broad beam to cover the United States, ground stations costing a million dollars are typical. At the other extreme, if the satellite has a high gain antenna with a narrow beam and only one signal to an educational television system, ground stations may be as low as \$700. In practice, the typical ground station costs for data communications will be \$100,000 on up. Smaller users will probably use telephone circuits to interface to the ground station while larger operations may use their own ground station and satellite transponder. Specialized microwave carriers will probably interface to the ground stations.

Are Microwaves 'Skimming Cream'?

What are the problems? First, the telephone companies feel the satellite and microwave carriers are skimming off the cream. The telephone companies object to taking a high volume section out of a company network for satellite or microwave transmission, and letting the telephone company serve the low usage applications. They object to network interconnect. The FCC is slowly solving this problem. The second problem relates to delays in satellite transmission. Due to the transmission delays, a terminal that operates at high speed will operate at only a fraction of that speed when synchronous data is transmitted in the same binary synchronous format by way of a satellite. The problem and potential solutions are known, but the equipment to correct the problem is not available today. A third problem is related to high usage applications. Although the military computers operate at higher data rates for large radar and target display systems, the commercial computers and tele-

By L. W. HILL

phone lines are limited at present to a peak 230,000 bits per second. This speed limit means computer tapes, drums, and disks cannot be effectively used at full speed in remote terminal communications.

Major Change: Digital Transmission

One of the major changes in data transmissions for telephone, microwave, and satellite communications is digital transmission. In 1961 the Bell System started to use the T1 digital carrier for carrier transmissions up to 50 miles. The next level between metropolitan areas uses the T2 carrier operating at higher data rates. Telephone studies showed that full digital transmission was not justified to the customer's site. This meant that a modem was required and analog transmission was an interface to the carrier system in the Bell System facilities. Technical and service problems were numerous, so that initially the T1 carrier developed into a dirty word for data transmission. It is still a critical problem in some areas due to phase jitter and harmonic distortion. Next year the telephone company is ready to provide digital transmission all the way from terminal to computer. Digital transmissions are currently in use in some microwave and satellite applications. A single voice-grade channel now supporting

a peak of 9600 bits per second with the present analog format may be changed to a data rate of up to 50,000 bits per second with the all digital format. The analog format error rate, typically at 1 in 10^6 bits, changes to about 1 in 10^8 bits for digital transmission.

There is another important technical problem for present high data rate transmissions over the telephone line. The telephone company line specifications, tariffs, test equipment, and standard practices do not match the requirements imposed by high speed modems. The modems may be those supplied by the telephone company or other manufacturers. For example, the telephone company's standard practices provide for the measurement of phase jitter and harmonic distortion using a fixed frequency in each case. Modems operate at a variety of frequencies across the telephone band. Valid tests should be made at a number of frequencies across the bandwidth. Second, there is no requirement that telephone companies must supply one type of test equipment to test a line. Different telephone companies on different ends of the line often have incompatible or inadequate test equipment and untrained installers. In spite of these problems, the telephone companies have upgraded the quality of long distance data transmission. From a practical point of view, and in accordance with FCC tariffs, the user must provide the test equipment and trained personnel to work with the telephone company in testing through his modems and isolating high speed data transmission problems. Three times last year, in three different sections of the country, I have had to provide test equipment and explain to telephone company personnel how to install equipment, run tests, and locate malfunctioning telephone equipment.

'Big Growth Still Ahead'

In closing, I would like to quote from the January 11, 1973 Wall Street Journal. "The big growth in data communications is still ahead. The Bell System, which had revenue of \$500 million from data services in 1970, expects the figure to climb to \$1.5 billion by 1975 and \$5 billion by 1980." You can see by this that we are in the earlier part of the Data Communications Revolution.

Coming in Jan./Feb. SID

Special Editorial Topic:

INFORMATION DISPLAY ARCHITECTURE

In addition, New Products, News of the Society for Information Display and Reports on Technical Meetings.

CATHODE RAY TUBES

WE OFFER YOU TECHNICAL ABILITY FOR ANY SPECIAL CRT AND DISPLAY SYSTEM

CRT
FIBER OPTIC FACE
BACK PORTED
MONOSCOPES
HIGH RESOLUTION
CUSTOM GEOMETRIES
PHOSPHOR SCREENS
ELECTRON OPTICS.
SYSTEMS
FLYING SPOT SCANNERS,
MONITORS, FIBER OPTIC
PRINTERS, DATA TERMINALS.



DESIGN — DEVELOPMENT —
PRODUCTION — TUBES AND
SYSTEMS.

M. SADOWSKY S. CARLISLE P. KEEGAN

SPECIAL PURPOSE TECHNOLOGY CO.

16300 LINDBERGH STREET, VAN NUYS, CALIFORNIA 91406
TELEPHONE: (213) 989-4610

Circle #3 on Readers Service Card

By A. M. HLADY
National Research Council
of Canada
Ottawa, Canada

A DISC-BASED MULTIPLE TERMINAL DISPLAY SYSTEM

A disc memory for refresh storage

The display system described in this paper was developed at the National Research Council of Canada as a part of an experimental program in Computer-Aided Learning (CAL).⁽¹⁾ It consists of a single display controller, a character generator, and a refresh memory unit which are all shared among several display terminals operated in a cluster. The present system can display alphanumeric information only, but it has been designed so that it can be extended to store and display gray-scale video images also. It is to be evaluated as a means

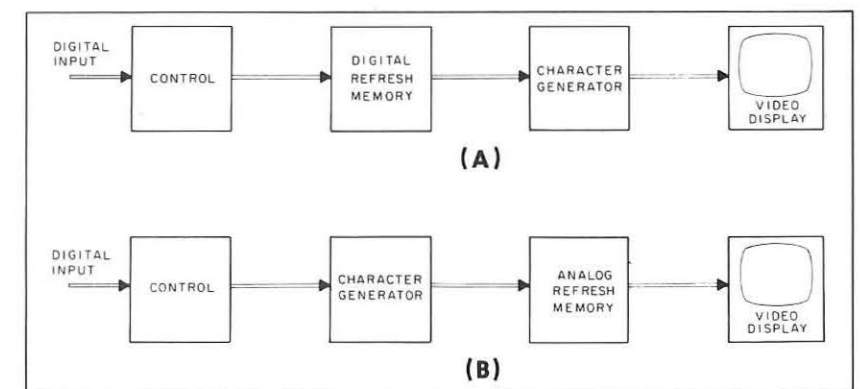

Figure 1. Raster scan CRT displays

of fulfilling the display requirements of a CAL classroom at a low cost.

The display technique decided upon is a raster-scan type with a standard 525 line TV raster. This choice permits the use of inexpensive TV monitors for display with gray-scale capability. Also, conventional TV techniques, such as screen splitting, can be used to combine information from several sources. A raster scan alphanumeric display can be based on a refresh memory that stores digitally coded characters or on one that stores two-level analog signals. In the latter case, a one-to-one relationship exists between the stored signals and the dots that are brightened on the screen. Figure 1 shows how the relative position of the character generator depends upon the

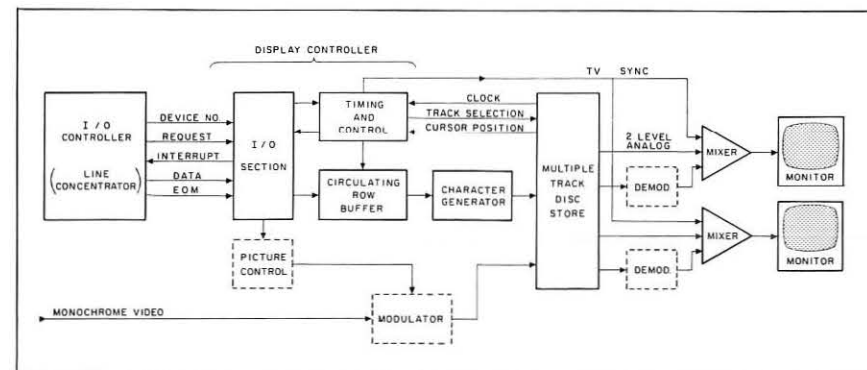

Figure 2. Display system schematic

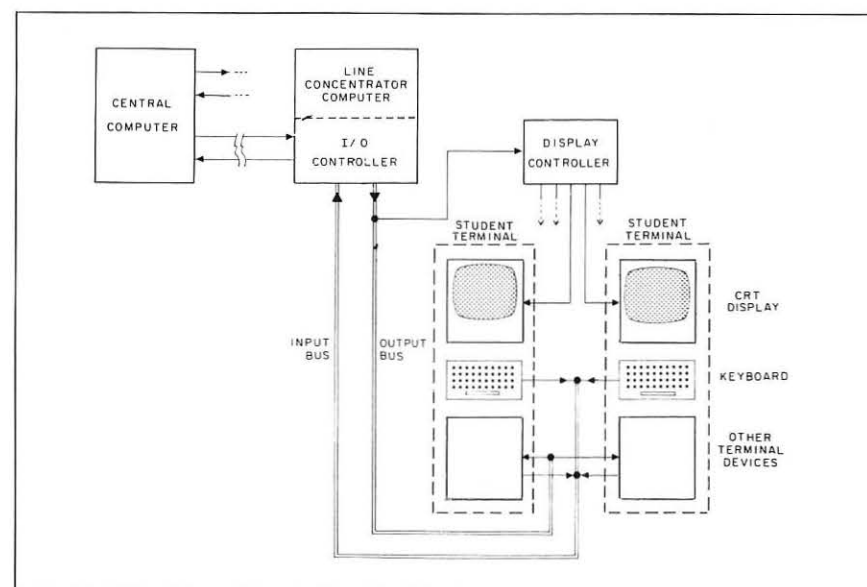

Figure 3. Configuration of a CAL system

type of refresh storage being used. In the configuration shown in Figure 1(a) (common to most stand-alone display units) character generation forms a part of the display refreshing process. The arrangement used in the NRC system, illustrated in Figure 1(b), permits sharing a character generator because it is required only once for each character being displayed.

Analog Vs. Digital

One disadvantage of analog storage over digital is that the stored information is not available for any further digital processing. So, to do any local processing of the displayed data, such as manipulation with a graphic input device, a copy of the information must be stored digitally in the processor.

The NRC display system is designed for a small computer at the front end to act as a line concentrator and I/O controller. Fig-

ure 2 illustrates the interconnection of the display system components. The dotted section indicates how the system can be extended to include the display of gray-scale pictures.

Figure 3 depicts a CAL system configuration in which a large central computer, containing all the course material, is shared by several remote CAL classrooms. A classroom would contain a small computer and a cluster of student terminals; each terminal including a CRT display, a keyboard, and other I/O devices, such as an audio response unit and a graphic input device. All of the terminal devices are connected to an I/O controller that forms a part of the line concentrator computer. In our experimental system, the central computer is a PDP-10. The line concentrator is a PDP-8 with an NRC designed I/O controller.

Refresh Storage

Refresh storage is provided by a multiple track, head per track, disc memory. Information is stored in analog levels representing black and white video elements. At the present time, a minimal system has been implemented using an available disc; a 64 track Data Disc Inc. model F6, which revolves at 30 rev./sec. and has a data transfer rate of 3×10^6 bits/sec. per track. The modified electronics includes read and write amplifiers for each track being used. Each of these tracks is dedicated to a particular display channel and contains one TV frame of information. A page size of 540 characters (36 columns by 15 rows) was determined by the capacity of one disc track. Paralleling tracks to obtain higher data rates was unsuccessful because of jitter between tracks.

Gray-scale picture storage can be accomplished by modulating a monochrome video signal and storing it on a separate track, but the picture resolution would be limited with the present disc. A disc with a higher data transfer rate will be required to provide pictures with full TV band-width. Such a disc also would permit alphanumeric displays of over 2000 characters per page.

Display Controller

The display controller can process data for only one display channel at a time. Therefore, it must have a means of retrieving the current cursor position for any channel when required. To minimize cost, the cursor position for a particular display is stored on the same disc track used to refresh that display. The position is stored on the portion of the disc track that corresponds to the horizontal blanking interval of the TV raster. It is repeated 525 times so that it can be accessed in an average of 32 μ sec.

When a particular display channel is requested, the display controller selects the appropriate disc track and the cursor position is loaded into a cursor register in the controller. Characters arriving for that channel are placed in an MOS row buffer that is circulating in synchronism with the horizontal TV scan. Characters are assembled in the row buffer until one of the following conditions occurs:

- 1) the row buffer is filled,
- 2) an end of message signal is received from the computer, or
- 3) a control character, such as Line Feed, moves the cursor to a different row.

When one of these conditions occurs, the controller goes into a character generation mode during which the assembled digital characters are converted into analog signals by the character generator and stored on the disc. The cursor position for that channel is updated on the disc at the same time. During the character generation mode, which takes 34 msec., the controller is busy and unable to accept more data.

In adding gray-scale capability to the system, the picture controller shown in Figure 2 must open a video gate for one frame time in response to a special control character. A suitable video source would be a TV camera which is synchronized to the system and optically coupled to a random-access film projector. Alternatively, a video tape recorder is a possible source if a servo-driven disc is used as the refresh memory.

Interfacing

Each display unit appears to the user as a separate terminal con-

nected directly to the central computer, but all messages for the display units must pass through the line concentrator computer. The display system, along with all other terminal devices, is connected to the I/O controller in the line con-

A multiple terminal display system based on a disc memory for refresh storage and containing a single display controller and character generator has been developed for a computer-aided learning application. Although the system has only an alphanumeric display capability at present, it is designed so that it can be extended to store and display gray scale video images at relatively low cost. Standard video monitors are used for display, and each alphanumeric display channel added to the system requires a disc track and a small amount of extra circuitry. The cluster of terminals is connected to a time-shared computer through a line concentrator. It is estimated that the system can service 15 terminals with an average refresh rate of about 30 cps for each.

centrator by an I/O bus. Each terminal device, and in particular, each display channel, is assigned a device number. A corresponding number sent out on the bus indicates the destination of information on the bus, and devices are polled

by stepping through the numbers sequentially. Each display channel has an interface circuit that consists basically of a line number decoder, a track selection latch, and a request latch for storing requests that occur while the display controller is busy.

An incoming message results in a request for the proper channel from the line concentrator. When the display controller is not busy, it responds with a computer interrupt, and it also selects the appropriate disc track for the requested channel. Data transfer is initiated by the computer interrupt. When the buffer in the line concentrator for that channel is empty, an end of message (EOM) signal is sent to the display controller.

Any shared system must have a means of allocating time to the various users of the system. In this case, scheduling is performed by software in the central computer and in the line concentrator. Messages arriving at the central computer are transmitted to the line concentrator in segments delimited by Line Feed characters. An I/O service program adds identifying headers and interleaves the segments. At the receiving end, the line concentrator strips the header from each segment, stores the segment in a buffer, and requests the proper display channel. Any character originating at the keyboard is treated as single character message by the line concentrator and is placed in a buffer for transmission to the correct display channel. The keyboard characters are also assembled into groups which are transmitted to the central computer each time a terminator character is typed in.

The display controller operates most efficiently with long message segments because the character generation mode requires the same length of time regardless of whether a message segment contains one character or a full row of characters. For this reason, the line concentrator is programmed to request

a display channel only after a complete message segment is available in its buffer. The result is that messages from the central computer appear on the CRT screen in segments up to a whole row in length rather than appearing character by character as on most displays. The amount of use that the other channels are receiving determines the length of time between segments.

Character Generator

A highly readable character set is desirable in CAL applications because of the intensive use student terminals can receive. The set of 95 printing characters conforms to the International Standards Organization (ISO) 7 level coded character set and includes ten lower case accented characters used in French text. Each character is formed on a 7 x 10 matrix of dots within an 8 x 16 character space for each TV field. The two fields per TV frame are interlaced, but they contain identical information. The descending characters such as "p" are placed 4 dots lower in the character space than the others. The photographs in Figures 4 and 5 show examples of the character set.

The read-only memory for the character generator consists of discrete diode matrices because of cost and ease of modification. In a commercial system these would be replaced by LSI integrated circuit ROM's.

System Timing

The basic clock signal for the system comes from a 5.55 MHz. oscillator which is kept in phase with a 2.775 MHz. signal recorded on a timing track of the disc. One cycle

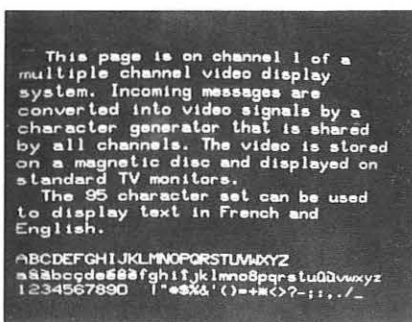

Figure 4. Example of a character display

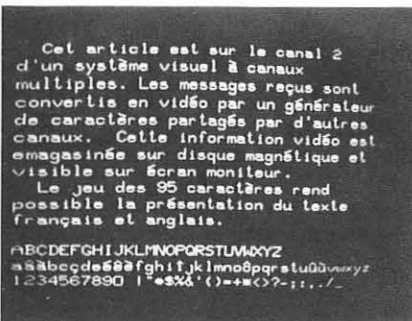

Figure 5. Example of a character display

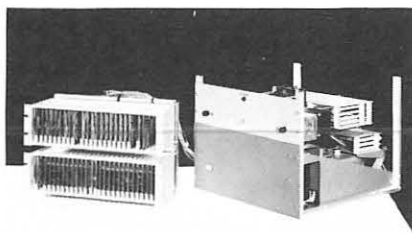
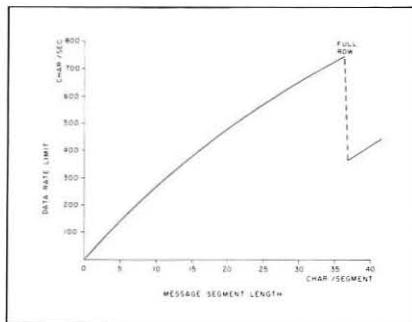

Figure 6. Display system hardware

of the 5.55 MHz. signal corresponds to the width of single dot or video element. In addition to being a timing source for the system logic, the clock signal is used to generate TV sync and blanking signals for the display monitors.

Another timing signal, a Disk



7. Combined data display rate limit

Position Reference pulse, which occurs at a fixed point on each disc revolution, is required to maintain a constant time relationship between the disc and the TV sync signal. This pulse is obtained from a gap detector circuit which is triggered by a 1 µsec. gap inserted in the timing track signal.

Conclusion

Figure 6 shows the display system. The disc drive, its read and write amplifiers and the system power supplies are on the right. The other chassis contains the diode matrices for the character generator on the lower row of boards, and the upper row contains the system logic, the character decoders, and the interface and video mixer circuits for the 3 channels used for system testing. Each display channel added to the system requires a disc track with read and write amplifiers, an interface circuit, and a video mixer.

With the present I/O controller, characters are transferred to the display controller in bit parallel form at a nominal rate of 2500 cps, but the actual transmission occurs in the form of bursts of characters at this rate interspersed with 34 msec. gaps for character generation. Figure 7 shows how the effective

turn to page 22



The finest CRT display engineers in the industry are looking for work

Setchell Carlson engineers have played a vital role in television display for more than twenty years, and for more than twenty years they've been looking for work! Not new jobs, but new challenges, new problems to solve.

It's this kind of attitude that has enabled Setchell Carlson to set the pace with such innovations as UNIT-IZED plug-in circuit modules. And it's also this kind of attitude, demonstrated by the company as a whole, that has resulted in a unique capability for data display custom design, a willingness to undertake the unusual, and the continued ability to produce superior products economically.

It's not surprising then that the Setchell

Carlson line of video monitors offers the rare combination of quality construction, superb data display, total ease of maintenance, unsurpassed reliability, and overall dollar for dollar value.

Look to Setchell Carlson for your display applications. If we don't build exactly what you need, ask us. If it can be built... Setchell Carlson can build it... and build it better than anyone else in the industry.

Write or call us now about your particular requirements. Our engineers may already have the solution AND WE'RE READY TO PUT THEM TO WORK FOR YOU!



about the author

Al Hlady is currently an Assistant Research Officer in the Information Science Section, Radio and Electrical Engineering Division of the National Research Council of Canada, which he joined in 1966. He has worked on the development of a touch-sensitive graphic input device and on display equipment for a computer aided learning system. Mr. Hlady received his B.Sc. (E.E.) in 1964 from the University of Manitoba and a M.A.Sc. in E.E. from the University of Toronto in 1966. He is a member of the society for Information Display; holds Canadian and U.S. patents on the touch-sensitive overlay; and has presented two papers on that device.

Properties of Resonant Scan Monitors For An Alphanumeric Display

By ROBERT W. WHITNEY
GTE Sylvania Inc.
Seneca Falls, N.Y.

I. INTRODUCTION

The resonant scan monitor has been given the leading role for displaying dot matrix alpha- numerics in the peripheral computer terminals because of its efficiencies and inherent lower costs compared to monitors using linear scan amplifiers. It has been competitively developed by the television industry. The computer terminal manufacturer just entering the business believes he should be able to buy a 12 inch monitor for \$50 since he can purchase a 12 inch television set at his local discount store for \$75

and remove half of the circuitry and only have to beef up the video amplifier. The performance being specified by the terminal manufacturer is however, far superior to the home entertainment television set.

This paper considers the performance being specified by the terminal manufacturers, the requirements versus compromises that are made to retain a "low cost" monitor, and possible cost savings of a system type approach between the terminal and monitor manufacturers.

II. Number of Characters Per Line Versus Monitor Size

In 1969, the computer terminal manufacturers were requesting monitors that could display 40 to

64 characters per line. The 12 inch monitor became a prime candidate for this requirement because of its compact size and its availability in solid state form from both monitor manufacturers and suppliers of converted TV sets. The 12 inch monitor remains the primary size even though the requirement for the number of characters per line has increased.

What are the considerations in choosing the CRT size for an alphanumeric display? The number of characters per line and the dot matrix to be used must be considered first. Let's take, for an example, a character generator which provides 64 characters per line for 24 rows using the 5 x 7 dot matrix with two dot spacing between characters and

A description of the role, performance and evolution of the resonant scan monitor in the display of dot matrix alpha- numerics in the peripheral computer terminal are described.

three dot spacing between rows of characters at a 60 Hz refresh rate. The EIA standard for horizontal blanking time is approximately 11.1 microseconds, which leaves 52.4 micro-seconds of writing time for standard TV scan rates. Leaving at least 1.2 microseconds of raster margin on both sides, the active writing time is 50 microseconds. The total number of dots per line for 64 characters is $64 \times 5 + 63 \times 2$ equalling 446 dots. A gated symmetrical square wave is usually used for the input video information. That is, the input ungated symmetrical square wave turns the electron beam "on" in its "one" state and "off" in its "zero" state. If no dot is to be displayed in a period of the square wave, the input is

turn to page 18

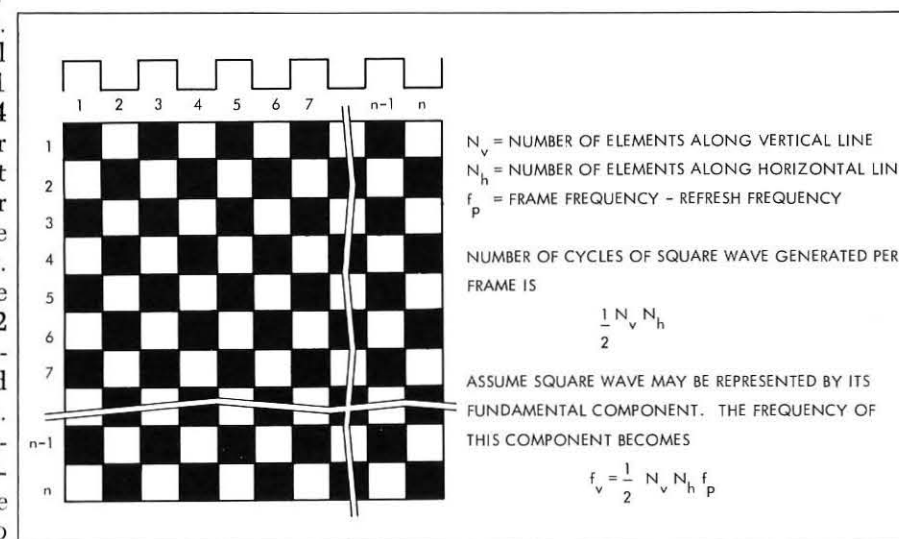

Figure 1. Checker Board Pattern — An Estimate of System Bandwidth.



PROCEEDINGS

The SID Proceedings are the major contribution to the literature in the field of information display. Carefully prepared formal papers, many presented at SID conferences and symposia, not only contribute to the state-of-the-art, but also supply historical data and survey articles concerning the field.

From 1963-1968, SID proceedings were published annually or semi-annually.

MICROFICHE Plans are under way to make available microfiche versions of all proceedings. As printed volumes go out-of-print they will be replaced with microfiche.

Contact SID for price and availability.



VOLUME 1, March 1963, Santa Monica, Calif. Proceedings of SID's First Conference emphasizes scan conversion and bright display, multicolor projection system, colordata, a photographic large screen display system, high ambient light displays systems, and human performance engineering.

159 pages, 93 illustrations . . . \$20.00.

VOLUME 2, October 1963, New York, N.Y. Papers for the Second Proceedings were selected on the basis of their relevance to problems of current and future interest. Partial contents include information systems, information systems, information science and responsibility, laser display techniques, and multicolor console processor projector.

283 pages, 145 illustrations . . . \$20.00.

VOLUME 3, February 1964, San Diego, Calif. This symposium concentrated on new techniques and devices as well as system design and human factors. The proceedings includes specification and test of display equipment, high ambient light display system and alpha-numeric CRT.

299 pages, 120 illustrations . . . \$20.00.

VOLUME 4, October 1964, Washington, D. C. The Fourth National Symposium explored the information display on land and in the air. Proceedings detail air traffic control, a matrix controlled generator, signal distribution for a large scale display, display requirements of the integrated management information systems, and a method for generating television mosaic displays.

383 pages, 179 illustrations . . . \$20.00.

VOLUME 5, February 1965, Santa Monica, Calif. This proceedings records the interplay between designers and users of display equipment and devices. Partial contents: Information systems for business and industry, developments in group displays, displays in simulation, developments in components and systems, vehicular traffic, and post 1970 displays.

332 pages, 148 illustrations . . . \$20.00.

VOLUME 6, September 1965, New York, N. Y. Proceedings of this two-day symposium include papers on dichroic filters and additive color displays, real time CRT-photochromic projection display, visual write-erase-nonstore and electrical readout, batch-fabricated computers, and challenges to the display field.

185 pages, 134 illustrations . . . \$20.00.

VOLUME 7, October 1966, Boston, Mass. This proceedings presents advances in both the theory and the application of information display. Contents (partial): Display devices and techniques, information processing as a function of display format, the observer-human factors and performance, display systems, and display standards.

287 pages, 184 illustrations . . . \$20.00.

VOLUME 8, May 1967, San Francisco, Calif. Papers in this Proceedings provide a graphic portrayal of the state-of-the-art and future insights. Contents include: Dry silver recording materials, the application of photochromics to color display, the plasma display panel, anaglyph stereoscopic CRT display system.

290 pages, 251 illustrations . . . \$20.00.

VOLUME 9, May 1968, Los Angeles, Calif. This proceedings records the ever expanding science of data transfer between men and machines. Contents (partial): Driver performance using an experimental route guidance system, computerized fingerprint classification, a high resolution closed circuit remote viewing system, and Holographic Real-Time display.

207 pages, 172 illustrations . . . \$20.00.

QUARTERLY ISSUES

Since 1969, SID Proceedings have been published in typeset quarterly issues. This procedure allows the most current information to be rapidly presented.

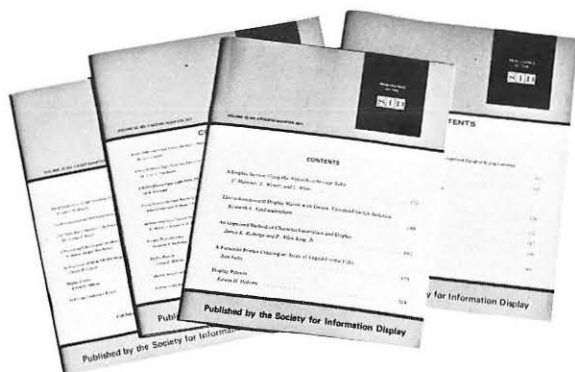

VOLUME 10, 1969

No. 1. Issue includes display technology, display programming and characteristics of automated display consoles. 65 pages, 45 illustrations . . . \$12.00

No. 2. Partial contents feature computer graphics terminal, ATC display and measurement of a CRT spot. 222 pages, 100 illustrations . . . \$20.00.

No. 3. Contents of this publication include performance of CRT tubes and dot matrix displays, multisensor processing, or dynamics electrographics. 36 pages, 25 illustrations . . . \$9.00.

No. 4. Partial contents: Plasma-fluidic hybrid display, fully shaded digital video and dynamic information storage. 78 pages, 75 illustrations . . . \$12.00.

VOLUME 11, 1970

No. 1. Contents include: Character generation by MOS ROM. Survey of digital plotters and interactive graphics. 48 pages, 58 illustrations . . . \$9.00.

No. 2. Trends in computer aided design requirements of holographic displays and digital TV displays are discussed in this issue. 48 pages, 56 illustrations . . . \$9.00.

No. 3. Inexpensive electronic memories, night vision displays, ID110m and GRAIL are described. 48 pages, 58 illustrations . . . \$9.00.

No. 4. Partial contents: Data compression laser photochromic display, filter effects and deflection amplifier compensation. 48 pages, 52 illustrations . . . \$9.00.

VOLUME 12, 1971

No. 1. Contents include light emitting diodes, matrix displays and display patents. 48 pages, 45 illustrations . . . \$9.00.

No. 2. Schlieren light valve, reflex electro-optic light valve and improved laser color system are included. 48 pages, 66 illustrations . . . \$9.00.

No. 3. Papers include CRT deflection system, microfilm printer for Chinese characters and index of display articles in current periodicals. 48 pages, 60 illustrations . . . \$9.00.

No. 4. Partial contents: Alphecon storage tube, ovonic threshold switch isolation and liquid crystal cells. 35 pages, 45 illustrations . . . \$9.00.

VOLUME 13, 1972

No. 1 Devoted to plasma displays, this issue contains ten comprehensive papers, on various display techniques, including low cost drivers, phosphor color, multicolor gas-discharge display and a quarter-million element display with memory. Also included is an index of display articles from current publications and abstracts of display patents. Editor: H. Gene Slottow

92 pages, 118 illustrations...\$9.00.

No. 2 This issue emphasizes important new aspects of liquid crystal technology with five full-length articles. Contents include liquid crystal display phenomena, cholesteric texture change, cholesteric-nematic phase transition and light scattering considerations. Editor: George E. Holz

32 pages, 42 illustrations...\$9.00.

No. 3 Volume includes discussion at the two-day Workshop of Display Terminals and Wired Cities held at the National Bureau of Standards in Gaithersburg during December, 1971. Contents cover applications, display terminal status, cable capabilities, summary charts of hardware and software, and a history of ASCII codes. Editor: E. A. Ulbrich

24 pages, 35 illustrations...\$9.00.

No. 4 Five papers describe new display techniques, including scanned LEDs, an 11-switch decoder, amorphous semiconductors and modular transfer function of CRTs. Editor: R. A. Ruehrwein

24 pages, 28 illustrations...\$9.00.

FUTURE ISSUES

VOLUME 14, 1973

No. 1 Volume includes selected display papers from the first USA-Japan Computer Conference. Editor: Dr. J. J. Brandinger

No. 2 A special issue dealing with display hardware/software comparisons compiled at RADC, Rome, N. Y.

No. 3 and No. 4 Papers from the SID Symposium and Exhibit held in New York during May, 1973. Included are papers from sessions on I/O techniques, solid state displays, liquid crystals, plasma displays, perception, LED's, CRT's, and applications. Individual quarterly issues are \$9.00.



SPECIAL PUBLICATIONS

SYMPOSIUM DIGEST

An important facet of the SID publications are the Digest of Technical Papers prepared in conjunction with the SID international symposia. Condensation of prepared papers and summarized views of panel discussions have been prepared. These digests serve as a detailed index to the full-length papers published in the quarterly proceedings.

1970 International Symposium Digest, May 1970

New York. Contents include: Matrix displays, plasma displays, projection displays, cathode ray devices, digital image processing, human factors, character generation and display system.

128 pages, 160 illustrations . . . \$15.00; Members...\$10.00.

1971 International Symposium Digest, May 1971,

Philadelphia. This issue covers presentation dealing with CRT technology, large screen projectors, color image reception, new display techniques, plasma displays, display applications, and liquid crystal displays.

144 pages, 151 illustrations . . . \$15.00. Members...\$10.00.

1972 International Symposium Digest, June 1972, San Francisco.

Topics include: Solid-state display technology, consoles, plasma displays, software, liquid crystal displays, CRT's, visual phenomena and peripheral equipment.

160 pages...\$15.00; Members...\$10.00.

1973 International Symposium Digest, May, 1973, New York.

This issue will include topics on display I/O techniques, solid-state display technology, plasma displays, liquid crystal displays, raster/vector graphic display systems, applications, aerospace displays, computer graphics and human factors.

Approx. 160 pages...\$20.00; Members \$15.00

HOW TO ORDER

Single issues, complete sets and subscriptions may be obtained from the Society for Information Display's Publication Department.

Address mail to: SID Publications, 654 North Sepulveda, Los Angeles, Calif. 90049. phone: (213)472-3550.

SUBSCRIPTION SERVICE

Subscriptions to SID publications give you prompt, uninterrupted service on future publications. In addition to reduced costs, subscription service saves you time and clerical effort. It also protects against increased prices during the subscription period.

Subscription to Proceedings.

Subscribers receive the four quarterly issues of the SID proceedings.

Subscription price...\$30.00 annually.

Publications Subscriptions.

Subscriptions to SID publications give you complete sets of the annual periodicals published by SID.

An annual subscription includes:

- One set of the quarterly SID proceedings.
- A subscription to the bi-monthly SID Journal.
- A copy of the annual SID Symposium Digest.

DISPLAY BOOKS

Recent Advancement in Display Media

Vol. I Out-of-print.

Vol. II This volume does much to provide the overview necessary to gain perspective on how the various display specialties juxtapose and enrich each other. Chapters describe plasma display terminals, VTOL IFR technology, fallout display systems, R&D in computer and information sciences, and computer processing for three-dimensional displays. Hard cover.

260 pages, 100 illus...\$10.00; Members...\$7.50.

Vol. III This compilation brings together extensive reviews of the literature in the field of information display. Included are electronic displays on aircraft control, digital printer/plotter graphics terminals, and experimental display processor for the DX-1, information acquisitions, and R&D in the computer and information sciences. Hard cover.

231 pages, 20 illus...\$15.00; Members...\$10.00.

Vol. II and Vol. III purchased together price...\$15.00; Members...\$10.00.

DISPLAYS CONFERENCE PROCEEDINGS

Conference on Displays, September 1971, Loughborough, England. Organized by the Institution of Electrical Engineers in association with the Society for Information Display (British Chapter), this conference spotlighted display techniques throughout the world. Evaluation of visual displays, man as an information receiver, information retrieval systems, bi-color display tubes, heads-up displays, air traffic displays, three dimensional CRT displays.

374 pages, 215 illus...\$30.00; Members...\$20.00.

ANNUAL SUBSCRIPTION

Annual subscriptions for future issues of the SID proceedings are available. Price \$30.00. Order yours today.

From 1963-1968, SID proceedings were published annually or semi-annually.

Libraries and other organizations requiring multiple copies at the same address receive substantial price reductions when using the SID subscription service. If more than three subscriptions are required, libraries may find it advantageous to become sustaining members.

Subscription Period	One Subscription	Two Subscriptions	Three Subscriptions
One Year	\$50	\$80	\$110
Three Years	\$130	\$220	\$310

Subscribers outside the United States may speed delivery by adding an airmail option of \$10.00 in the Western Hemisphere; \$15.00 in Europe; and \$20.00 in the rest of the world.

SID Journal Subscriptions.

For information concerning subscriptions to the SID Journal, please contact Blackwell Publishing Co. directly, 1605 Cahuenga Blvd., Los Angeles, Calif. 90028

SOCIETY FOR INFORMATION DISPLAY
645 North Sepulveda
Los Angeles, California 90049

gated to the "zero" state in the digital terminal. No other blanking pulse is required from the terminal at any time. The frequency of the symmetrical square wave for this example is 446 dots divided by 50 microseconds or 8.92 MHz. Therefore, under ideal or theoretical conditions, a step function with a duration of 56 nanoseconds would be applied to turn the electron beam of the CRT "on".

The 12 inch monitor with a TV quality CRT is just the correct size for displaying 24 rows of 64 characters per line using the 5 x 7 dot matrix. The criteria for this statement are that each dot just touches each adjacent dot at the half-amplitude point without overlap and the average spot size is 0.020 inch. The 12 inch monitor is capable of a 9 inch x 7 inch display area. A spot length, neglecting other parameters, is 0.010 inch. Since the "on" and "off" times for the electron beam are equal in this case, the distance between dot centers is 0.020 inch and 446 dots will require 8.92 inches. An aspect ratio of 9 to 4.8 can be obtained when the 240 lines are just touching at the half-amplitude points.

Displaying 80 characters per line on a 12 inch monitor with a TV quality CRT is a compromise with the criteria set for the 64 characters per line due to CRT spot size. The terminal manufacturer must now consider the cost-performance trade-off of either overlapping the half-amplitude points 40% for a 9 inch horizontal display or specifying an average half-amplitude spot size of 0.016 inch. A 10 inch horizontal display requires either a 20% overlap of dots or an average spot size of 0.018 inch. However, a 10 inch display compounds the problem due to the deforming in the corners. The terminal manufacturer must consider the price of high-volume TV picture tubes or a small-volume, higher resolution CRT.

III. Bandwidth Considerations

There are two methods which can be used to calculate the required bandwidth of the video am-

plifier. The first is the checkerboard pattern method used for an estimate of TV system bandwidth (Reference 1); the second is pulse theory through linear networks (Reference 2).

The checkerboard pattern method is shown in Figure 1. For the 64 characters per line display just discussed, f_v is equal to 17.84 MHz and for the 80 characters per line f_v is equal to 22.32 MHz.

Figure 2 shows the response of an RC filter to rectangular pulses. If the bandwidth is equal to $\frac{1}{\pi}$ the output pulse is a recognizable

pulse, roughly π seconds in width, but far from rectangular. The rise time is approximately half the pulse width. When the bandwidth is much less than $\frac{1}{\pi}$, the output is much broader than the input and peaks only slightly; it is a grossly distorted version of the input. For the 64 character case $\frac{1}{\pi}$ is equal to 17.84 MHz and for the 80 character case $\frac{1}{\pi}$ is equal to 22.32 MHz. These bandwidths correspond to the checkerboard pattern method, but the checkerboard method does not consider rise and fall times of either the input or output pulses.

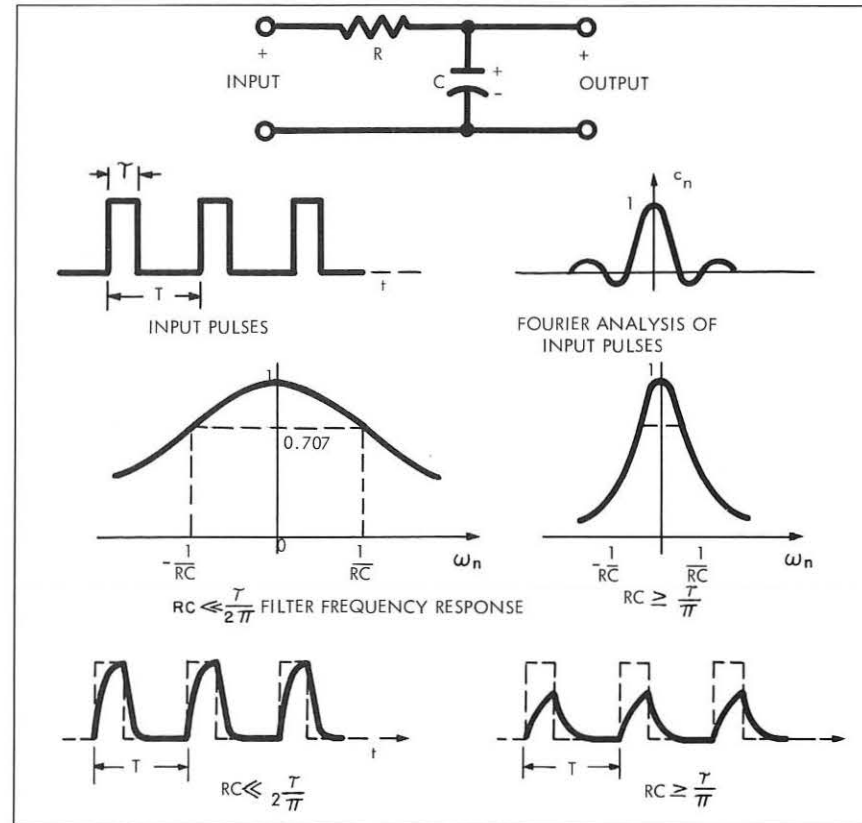

Figure 2. Summary of RC Filter Response.

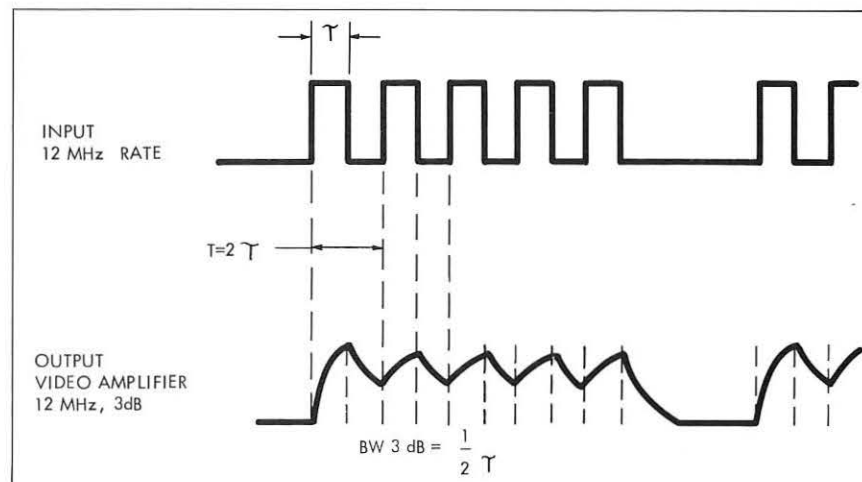

Figure 3. Video Amplifier Response to Top Bar of Letter E Alpha-Numeric Display.

The low cost monitors on the market today have bandwidths between 8 and 12 MHz. Figure 3 shows a typical output of the top bar of an E or T from a 12-MHz video amplifier when the input clock rate is 12 MHz ($BW = \frac{1}{2}T$). The top bar of the E or T will appear to be stroked with a higher intensity at the peaks of the waveform. If the amplifier is slightly over-peaked, the first pulse will have an overshoot which will be brighter than the following dots.

The solution to bandwidth for alpha numerics is a switching-type amplifier with rise and fall times in the 20-nanosecond region. This would allow the pulse to remain at full amplitude for approximately 20 nanoseconds instead of just a peak. The design of the switching amplifier is not as easy as it might appear. Most of the linear amplifiers operate from the brightness voltage supply, which is greater than 100 volts and therefore, the video output transistor must have a V_{ce} of 150 to 250 volts. High-voltage, fast-switching transistors are not consistent with the laws of today's physics and even if they were, several-hundred milliamperes would have to be switched to obtain 20 nanoseconds rise time with a minimum load capacitor of 10pf. It is desirable to have a CRT with a 20 to 25 volt peak-to-peak "on to off" characteristic, but the 20-mm low G_2 CRT's have 40 to 50 volt peak-to-peak drive characteristics which require more current gain stages to switch the output current. An additional collector voltage supply between the low voltage and brightness supplies is required. These are some of the cost-performance trade-offs in the video section.

IV. Geometric Distortion

Geometric distortion, which is a measure of raster non-rectangularity and scan non-linearity, is one of the most difficult areas for a low cost monitor. The raster for an alpha numeric display is usually under scanned and nearly all used for the display. Therefore, raster pincushion, barrel, trapezoidal, and non-linearity, as shown in Figures 4 and 5, are very objectionable to the user.

The yoke is primarily responsible

for pincushion, barrel and trapezoidal distortions. The entertainment TV set yoke is not good enough without correction for alpha numeric displays. The yoke represents a tradeoff between good corner focus and pincushion or barrel characteristics. It is possible to wind a yoke for very good rectangularity, but the corner focus becomes poor; it is also possible to

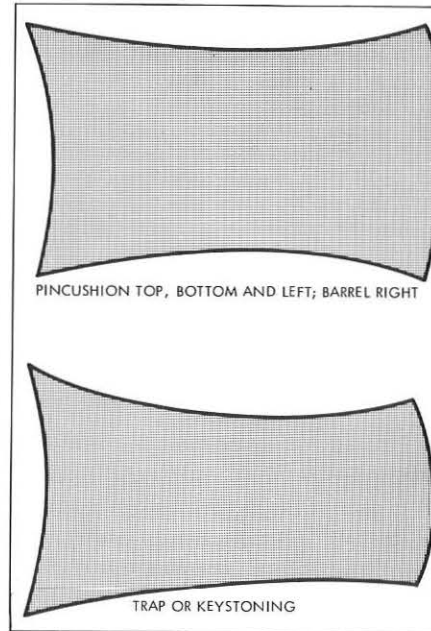

Figure 4.

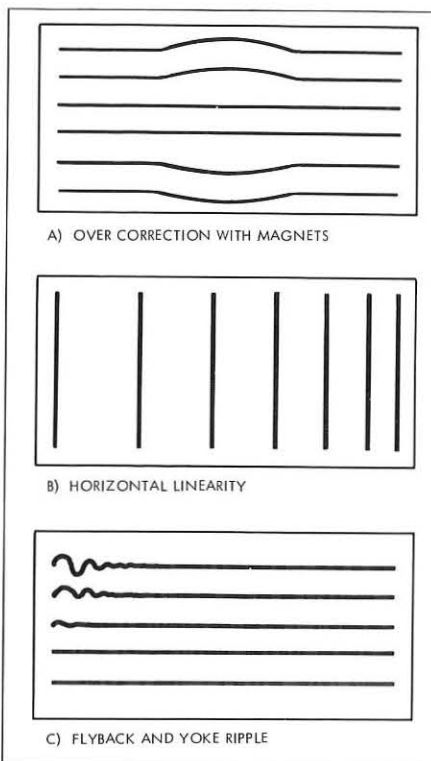

Figure 5.

wind the yoke for very good corner focus but with extreme pincushion. The compromise is fair corner focus and pincushion correction by permanent magnets, placed on the front edge of the yoke where needed. Figure 5A shows the effect of correcting for too much pincushion at the top and bottom with a strong magnet. The magnets have an effect on the electron beam at the top and bottom. The CRT also can be the cause of non-rectangularity if the gun is misaligned on the center axis. This places the non-deflected spot off center. Horizontal linearity of the low cost TV is unacceptable for an alpha numeric monitor. The resonant scan has the characteristic of fast scan on the left and slow on the right, which stretches the horizontal dots on the left and crowds them on the right (see Figure 5B).

Compared to the center, the extreme top bar of an E or T can vary as much as $\pm 30\%$ without correction. Horizontal non-linearity can be corrected by the use of a saturable reactor and by smoother switching of the output transistor.

Another horizontal distortion is either flyback transformer or yoke ringing or the combination of both. The ringing occurs at the third harmonic of the horizontal scan frequency to which the system is tuned. It is noticeable in the upper left side of the display and damps out as it scans across the CRT (see Figure 5C). The flyback ringing specification for a monitor is 15% of the flyback pulse compared to 25% for an identical TV set flyback transformer.

Vertical linearity appears as either stretch or crowding at the top and bottom compared to the center. This linearity varies from unit to unit on many low cost monitors because of large part tolerances. One major source of vertical non-linearity is the start of data writing before the vertical retrace has settled. Some terminal manufacturers' units start writing on the fourteenth line. The monitor retraces in 13 lines but is not settled. The EIA specifies 21 lines for re-

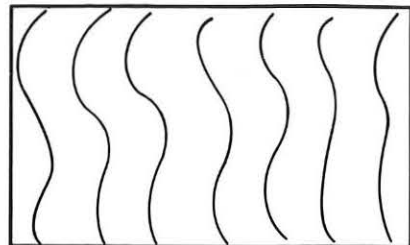

HUM EFFECTS ON RASTER

Figure 6.

trace to settling time. The vertical retrace and settling time can be drastically reduced from 21 lines by using a higher voltage output transistor and not limiting the retrace pulse. The higher voltage transistor, of course, adds to the cost of the monitor.

It becomes quite apparent that the quality of the low-cost monitor must be improved over that of a low-cost home TV set, particularly in the high-cost items such as flyback transformers and yokes plus the addition of a linearity coil and selection of top-TV quality CRT's.

V. Raster Stability

A monitor may have sufficient spot size, video bandwidth and good static geometric characteristics but be plagued by raster instability. Raster instabilities are caused by input line voltage transients and variations, 60-Hz hum and noise on the video input, asynchronous weave, inadequate sync processing and AFC time constant.

A low voltage regulator suppresses the input voltage transients from momentarily disrupting the video presentation. This regulator also prevents the display from

"breathing" with input voltage variations. Sixty-Hz hum and noise on the video input can modulate the video output and the sync separator. The hum makes the display break up as shown in Figure 6. The swimming effect gets more pronounced as the hum amplitude increases. The noise effect is like that of electric razor interference on a television set. The degree of the disturbance of hum and noise on the display depends on the sync processing circuitry and AFC time constants respectively. The sync separator can be designed to reject the 60-Hz hum before it disturbs the vertical synchronization, at the cost of added circuitry. The AFC time constant is a compromise between: 1) faster horizontal recovery from the difference in the serrated and regular horizontal sync pulses every 1/60th of a second, which can cause vertical bending at the top, and 2) slower recovery in order to be non-responsive to noise impulses.

Asynchronous weave is caused by the beat frequency between the input power frequency and vertical sync pulses; this frequency is neither exactly 60 Hz nor phase locked to the line. Care in power transformer lead dressing can reduce this raster instability. Sometimes shielding of the AC power line within the monitor is required. The monitor manufacturer must be ready to modify a circuit and add shielding or whatever else is needed to accommodate the many different terminal configurations.

VI. Interlace

Good 2:1 interlace is essential for the 10 x 7 dot matrix which refreshes at a 30-Hz frame rate. Separate or external sync provides better interlace than a composite input signal. A long persistence phosphor such as P39 is required to prevent

flicker on an interlaced dot matrix display.

VII. New Generation of Monitors

The alpha numeric display evolved from a modified television set to a fairly high resolution display with good geometric characteristics and still maintained a low price. The new generation of monitors is emerging with improved CRT's, switching video amplifiers and direct horizontal and vertical drivers. The latter is an instance where the monitor and terminal manufacturers can treat the two equipments as a system. With properly timed TTL inputs, the monitor manufacturer can take out the oscillators and AFC circuitry. This results in improved performance at a possible cost savings.

VIII. Summary

The performance requirements for video presentation of alpha numerics on a CRT are far more demanding than those required for the entertainment TV set. These superior requirements exist in CRT spot size, video bandwidth, geometric characteristics and raster stability. The areas that require improvement are the higher priced components of the TV set such as CRT, yoke, flyback transformer and addition of a linearity coil.

The basic properties of the resonant scan monitor (efficiency of the electron beam scanning and retracing across the CRT) are the real reason for its major role in displaying alpha numerics. The development of this resonant scan technology in such a competitive manner belongs to the television industry. ■

REFERENCES

1. Anner — "Elements of Television Systems"
2. Schwartz — "Information Transmission Modulation and Noise"



about the author

Robert W. Whitney joined GTE Sylvania, Inc. in 1959, with the Electronics Systems Division. Since 1969 he has been Engineer-in-Charge of the Display Engineering Section of the New Products Group, Seneca Falls, N.Y. He holds a degree in electrical engineering from Purdue University; and has taken graduate courses at the State University of New York.



id
APPLICATION
on GM or
FRIGIDAIRE
RANGE

A revolutionary new electric range with unique "touch" controls, developed by Frigidaire Division of General Motors, brings computer technology into the kitchen on a practical basis for everyday use by the homemaker, simplifying home cooking operations.

This commercial application of information display is of interest in that it indicates a new field of endeavor for our members. A request for a detailed technical description was understandably denied by Frigidaire to protect its competitive position. Most members of SID probably could design such a system; but Frigidaire is to be congratulated on doing the design, then bringing it into production, presumably on a commercially viable scale.— Editor.

In announcing the product innovation, Harold W. Campbell, General Motors vice president and Frigidaire general manager, said that a touch of the finger on the control panel will initiate cooking commands, and a logic circuit similar to those used in a computer does the rest. The system also includes automatic oven cleaning.

The new range employs an illuminated digital information display system more commonly known as a visual "readout," which has become so familiar in present day electronic calculators, cash registers and other products using modern computer technology.

"The new range makes use of a total system approach," Mr. Campbell explained, "eliminating some of the conventional electro-mechanical components with their many moving parts and replacing them with a glass touch panel, integrated circuits and solid state components."

An extension of this innovative new system may be applied to a countertop cooking unit and wall oven.

The procedures for operating the

new ranges are similar to the conventional type. There is an attractive control panel made of tempered glass that has neither knobs nor holes and permits easy cleaning. The lighted numerical display on the panel indicates the settings made for time and cooking functions and can easily be read by the homemaker, even in a darkened room. Accuracy of timed functions is controlled within a few seconds.

Several new features and improvements are included in this new "Touch-N-Cook" range. The first solid state digital "Cook-master," providing oven cooking, is featured. A pre-heat cycle is automatically programmed with use of the oven. Selected surface units can be turned off automatically after a pre-set time. A cook-and-hold feature keeps food warm for delayed meals. Range functions that have been selected can be recalled for display on the control panel by the touch of a finger.

The system is easy to use. For example, if the homemaker wants to cook a roast that would be ready for the evening meal — first, she

touches the control marked "start time," then the numerals "300." This indicates the oven will start at 3 o'clock. Next she touches the control reading "oven" and the numerals "325." This is the Fahrenheit roasting temperature for the oven. Finally, she touches "stop time" and "600." The oven will turn off at 6 o'clock. Having programmed the oven for cooking the roast, she would probably touch "clock" and the "readout" panel would resume showing the correct time. From this point on, the operation is automatic, having been "filed" in the memory bank.

The oven-cleaning feature has been simplified. The homemaker locks the oven door and touches the control marked "clean." The oven is already programmed for the cleaning cycle. When the cleaning period ends, the "lock" signal light goes off, and the oven can then be unlocked and used.

Any errors in setting, which are beyond the designed limitation of the range, are immediately indicated by a flashing display. A double touch of the "off" pad turns off all cooking functions simultaneously for the homemaker's convenience.

The range has an automatic broil cycle which controls heater wattage and broiling time for varying degrees of doneness. The end of timed oven or surface unit cooking is indicated by a tone sound. An appliance outlet is included in the circuit for timing delayed starts.

Mr. Campbell said that the innovative range opens a whole new vista for incorporating computer technology in appliances and could mark the beginning of an era of new electronic controls for greater flexibility, increased reliability, convenient operation, and ease of service.

New Company

Dr. Warren Ruderman announces formation of a new service-oriented company, Interactive Radiation, Inc. (INRAD) in Northvale, New Jersey. INRAD will specialize in custom design and development in the fields of crystal technology, acousto- and electro-optic components, and systems combining the sciences of chemistry, optics, physics and electronics.

Disc Based Multiple Terminal

continued from page 12

tive data rate varies with message segment length. This data rate is the combined input rate for all channels. In the best case, where the message segments are exactly one row in length, the data rate is limited to 750 cps. At the other extreme, the data rate limit for message segments containing one character is only 30 cps. It would appear that 6 users all typing at 50 words/min. could load the system completely because keyboard inputs are normally treated as one character message segments. However, this is not the case, because, when heavy keyboard usage occurs, some of the keyboard characters are assembled into groups of two or more, which raises the data rate limit high enough to accommodate the load. Assuming that a mixture of keyboard input and computer data results in an average message segment length of ½ row or 18 characters, the data rate limit is about 440 cps. This means that 15 people could use the system simultaneously with performance.

This shared system philosophy should become less attractive economically as individual video frame stores and LSI digital storage decrease in price, but at the present time, this system appears to be a practical way of providing CRT terminals capable of displaying both alphanumeric and gray-scale images

References

1. Brahan, J. W. and Brown, W. C., "The NRC Computer Aided Learning Cooperative Research Project", Proceedings of the Canadian Symposium on Instructional Technology, Calgary, Alberta, May 24-26, 1972.

SPSE Conference

Society of Photographic Scientists and Engineers (SPSE) will hold its 27th annual conference April 28-May 3, 1974, at Sheraton Boston Hotel, Boston, Mass. James F. Harvey, General Chairman, Technical Operations, Inc., Northwest Industrial Park, Burlington, Mass. 01803.

Big Space Demand At NCC Show

Reservations for exhibit space at the 1974 National Computer Conference at McCormick Place in Chicago, May 6-10, have been accepted from more than 120 companies, and more than 640 booths already are booked. The figures represent a substantial increase over the 1973 NCC, with reserved floor space already exceeding total space utilized for the 73 NCC. The 1974 National Computer Conference & Exposition will be held May 6-10, with an anticipated 300 exhibitors occupying more than 800 booths. SID is affiliated in sponsoring the conference and exhibit.

The 74 NCC will cover the full spectrum of computer applications and interests with every major segment of the industry represented — from minicomputers to mainframes, packaged programs to peripherals and CRT's to communications equipment. Such companies as AT&T, Burroughs, Control Data Corp., Data General, Digital Equipment Corp., Hewlett Packard, IBM, and Tektronix already have reserved space. The show is sponsored by the American Federation of Information Processing Societies.

DPMA '74 Meeting

Data Processing Management Assn. holds its 1974 conference and exposition at Minneapolis, Minn., June 24-26. Educational sessions and accompanying exhibits will be integrated for learning benefits. Contact John A. Guerrieri, DPMA, 505 Busse Hwy., Park Ridge, Ill. 60068.

LED Display Maker

Xciton Corporation plans to produce LED displays slanted toward the newly booming calculator market. Basically an offshoot from GE Research Labs, the new company will operate from a 12,000 square foot plant in Latham, New York. Dr. Allen M. Barnett, founder/president of the company, said they plan to have their first line of gallium phosphide displays on the market in 1973. Xciton products will be sold by Compar Corporation, Burlingame, California.

THE IMPERSONAL BENEFIT

By WILLIAM CARSON
Institute of Behavioral Science
Boulder, Colorado

Public distress with dehumanizing aspects of industrial and bureaucratic automation often focuses on computer-related equipment and operations. It now appears that the very impersonal quality of this equipment, which in some circumstances is experienced as depressing and threatening, when correctly combined with other properties can be stimulating and can reduce the psychological threat of a situation. Computer display terminals driven by appropriate software meet the evident requirements for this enhanced interaction.

We are all familiar with the unappealing aspects of computer-related operations, for instance stark computing facilities or equally barren "personalized" form letter solicitations in the mail. A look at some situations, in which contact with such equipment and operations is decidedly appealing, suggests a more constructive role for the "impersonal" characteristic of some interactive equipment.

Public Participation. Recently the city of Boulder, Colorado, conducted a study of the preferences of citizens relative to considerations of population growth in the Boulder area. Part of the study was undertaken by the Program of Re-

EDITOR'S NOTE: William Carson of the Institute of Behavioral Science of the University of Colorado recently was appointed Social Implications Chairman, Society for Information Display, after having served two years as a committee member.

His article discusses some extraordinary CRT applications which appear to enhance the value of such devices to society at large; and to overcome some of the general public's mistrust of computing engines.

Social Implications Committee, SID

search on Human Judgment and Social Interaction at the Institute of Behavioral Science (University of Colorado) and entailed extensive citizen display terminal interaction with programs designed to extract the users' judgments relative to growth variables (a future article will deal with the use of display terminals for human judgment applications). Except for elderly citizens, for whom the content of the task seemed to be threatening, namely "the future", the interactive part of the growth study had great appeal for the participants.

Other efforts organized to implement or study the use of interactive terminals for public participation in government decision making indicate that participants have similar responses.

Computer Aided Education. A finding in CAI projects is that students like interaction with terminals, providing the interactions are rich enough in variation, and providing corrective feedback cannot be interpreted as disapproving.

An interesting twist about CAI, and one of its main justifications, is that when done well it gives students more "personalized" attention than is generally available from traditional classroom methods.

Mental Health Patients. Dr. John Gillis at Big Spring State Hospital, Big Spring, Texas reports that his patients get along with display terminals very well, and that schizophrenic patients who would ordinarily perform poorly in socially neutral learning tasks, do as well as "normal" subjects when interaction is with a terminal rather than with hospital personnel.

The 'Mistrusted' Computer

These situations suggest the following questions. Why, when the public mistrusts "computers" so, are paranoid schizophrenic patients, champions of mistrust, so happy to interact with a computer through a display terminal? Why are students, who are sufficiently concerned with the impersonal nature of higher education that they are prepared to refer to a college or university as a "degree mill", also happy to interact with a computer through a display terminal? And why, finally, does the voting public, which seems to mistrust both computers and politicians, enjoy sitting down for a terminal session in which they reveal in a very detailed way their judgments concerning public policy questions?

The examples provoke the following observations. The patients of Big Spring State Hospital took to the display terminals so well that the clinicians and researchers are formulating a program to make clinical use of the machines. The impersonal (socially unloaded) quality of the devices together with the high motivation by patients to interact with such responsive equipment, make the terminals unusually well suited to the highly sensitive job of rehabilitating the patients with regard to their use of socially threatening concepts. It is evident that the patients want to interact:

they are attracted by the responsive nature of the terminals (as is the author). With people, their interactions are guarded and limited, but with a terminal the threat of judgment — disapproval — disappears and they are not hampered by such considerations when applying themselves to the tasks required. The situation with CAI is similar. In a traditional classroom, a student learns quickly not to ask questions which might provide important information but might at the same time appear stupid to the teacher. The student gets not only an answer to his question or remarks, but a judgment from the teacher as well. Indeed, CAI software which comes on too much like a strict schoolmaster can be as much of an impediment to learning as an excessive pedagogue. Stuart Umpleby at the University of Illinois Plato Project quotes a user complaint: "I was angry at being told what to do in such a demanding way by a machine. My hands felt slapped each time I made a mistake." On the other hand, at a well-behaved terminal a student can, given the system, go through "what if" sequences, and intentionally try "unlikely" or "wrong" approaches to see what will happen, without the threat of disapproval. One can see the same features of the man/machine situation at work



Mental Patient at Big Spring State Hospital, Texas.

in public participation applications. Here there is the responsiveness of an interactive computing system in addition to the traditional, useful privacy of the voting booth. It is interesting to see that the Delphi method, dependent upon anonymity for achieving group results superior to those of the best group member, in frequent use in conjunction with experiments in public participation in government.

Computer display terminals seem to have properties which place them very favorably relative to two highly important, deeply formed aspects of human information processing:

1. exchanging information through direct interaction (asking questions as a child, communicating requests, etc.)

2. including a social component in the formulation of responses to objective human information processing requirements (solving a problem or making a judgment while not getting on the wrong side of the parents, teacher, boss, wife/husband, colleagues, et al.).

As concerns interaction, the terminals provide the lively action we relish with our information exchanges (e.g., it would have been more stimulating for us to discuss this than for you to read it and for me to write it). Impersonal display terminals remove the judgment and potential disapproval implicit in interactions with other people, especially in situations which are hierarchically structured—and few aren't.

Cultivation of a taste for learning, problem solving and decision making, objectively and without the usual extraneous component devoted to avoiding disapproval and/or winning approval, would have a long-term benefit in improved human information processing.

Display Terminals



New series of complete CRT display terminals, called DESIGN III, has been announced by Ann Arbor Terminals, Inc. Series is termed a complete departure from past configurations, featuring contemporary molded-case design which contains (in addition to a 14" CRT monitor) building-block circuit cards directly interchangeable with Ann Arbor's present Series 200 modular display controllers and keyboards. Operating speeds to 9600 baud asynchronous are standard.

DESIGN III is available with serial or parallel data interface in 16 standard RO, KSR, and ASR models, including character or cursor addressable loading and burst loading types. The display set consists of 64 (upper case) or 96 (upper/lower case) characters, with display formats up to 40 lines x 80 characters. A built-in MOS dynamic shift register stores the full screen of data. Terminals are delivered plug-compatible with user's equipment, and may typically be installed in less than three minutes, it's asserted. A remote video port is included, from which up to 10 EIA standard 525-line video monitors may be daisy-chained for simultaneous local or remote viewing.

Size (including separable keyboard) is 14.1" (35.8cm) H x 20.3" (51.6cm) W x 27.1" (68.8 cm) D, and weight is approximately 49 pounds (22.2kg). Power requirements are 87 to 130V, 60 Hz, or 210 to 240 V, 50 Hz, switch-selectable. Typical option configurations of DESIGN III include double-size characters, external synchronization, strip chart and full graphics.

Circle #101 on Readers Service Card

NEW PRODUCTS

SID SID SID SID

New Spotmeter

Traditional "Spectra accuracy" for budget costs is claimed by Photo Research for new Spectra® "Mini-Spot"™ Silicon Cell Spotmeter, precision-made instrument designed for measuring luminance (brightness) where expensive, sophisticated instruments are not needed. Self-contained, hand-held "Mini-Spot" has 1° angular coverage, 21° viewing field and see-through optics, with meter reading simultaneously displayed in viewing field, for easy measurement of screen brightness and uniformity, CRT displays, microfilm readers, OSHA lighting inspections, EPA pollution measurements, brightness of light sources and lighting evaluation of buildings, roads and parking lots.



Low-range sensitivity of the new Spectra® Mini-Spot is 50 foot-lamberts full-scale, with readings legible down to 0.5 fl, while the high-range value of 1,000 fl may be increased to 100,000 with accessories.

Circle #102 on Readers Service Card

Disc System

Hewlett-Packard Company's data systems division has developed a new, more powerful disc operating system. DOS-III, designated HP 24307A, is said to give full control of system hardware and software capabilities either through the console or through batch processing. An added feature is an extended file-management package that produces more efficient file-handling. DOS-M, although supplanted, will continue to be supported for specialized applications.

Circle #103 on Readers Service Card

Demodulator

Exar Integrated Systems has an FM stereo demodulator that uses a unique phase locked loop technique to derive the right and left audio signals from the composite audio signal. The XR-1310" needs no external LC tuning tanks." It is aligned simply with a single non-critical potentiometer adjustment. Also, the stereo/monaural switch is inside the XR-1310, and has a 100 mA direct lamp drive capability. These features are said to result in a low external parts count, improved reliability, and savings in cost and package count.

The device offers excellent performance with 30 dB minimum channel separation, 0.3% total harmonic distortion, and inherent SCA rejection of 80 dB. It also has a wide dynamic range, allowing a maximum composite or monaural input signal of 600 mV RMS or 2.8Vp-p. The XR-1310 is available in a 14 pin DIP and operates over a -40°C to +85°C temperature range.

Circle #104 on Readers Service Card



about the author

W. B. Carson is Systems Analyst at the Institute of Behavioral Science, University of Colorado. He is responsible for software development and operations at the Institute's Interactive Computer Graphics Facility.



Readout Module

Industrial Electronic Engineers announces the compact 0865 Readout Module. Capable of displaying anything reproducible on film — photographs, alpha-numerics, graphics or worded messages and instructions—each Module can produce 24 discrete multi-colored messages with character heights to 1/2" in little more than one square inch of panel. Four Modules assembled with a common viewing screen (see photo) will produce 96 messages in an area slightly less than 1 1/2" x 5".



Since any color combination can be projected, full color graphics, colored legends and alpha-numerics or single color backgrounds can be displayed and viewed easily.

Circle #105 on Readers Service Card

Printer-Plotter

New wide-bed electrostatic printer/plotter made by Gould Data Systems for scientific and engineering use is described in a company brochure. The four-page brochure contains specifications for the Gould 5100, which produces computer-generated graphics on 22-in. paper. Specialized software packages also are described.

Circle #106 on Readers Service Card

Memory System

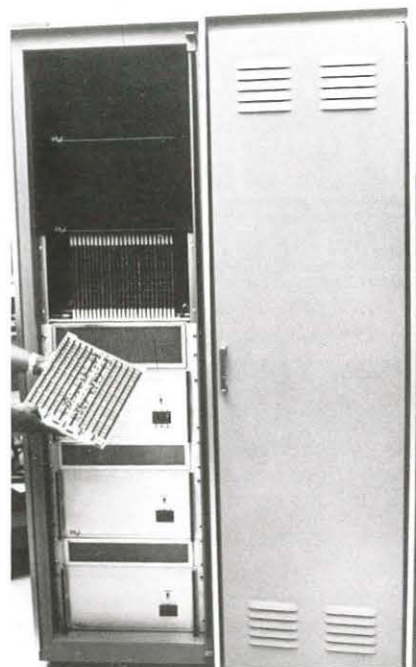

Intel Memory Systems has what it believes is the "world's largest shift register memory system". System, developed for a government agency, is being used to replace a large drum memory. System consists of 9 channels, each channel having 4.8 million bits of storage. System is packaged in three cabinets, each containing three channels. It is organized 480K words by 10 bits and was delivered complete with power supplies and cooling systems as integral parts.

System features Intel's in-60A memory cards. The in-60A memory card is organized 20K words by 10 bits and features speeds up to 3 MHz clock rate. The system is available with 6, 7, 8, 9, or 10 bits per memory card and is expandable to virtually all bit or word lengths by the use of additional memory cards. System is fully buffered and features an adjustable clock rate from 3.0 MHz to 10 KHz. It is TTL compatible and has up to 10 single ended lines for input and output.

DC power requirements are +5V, ±5% at 5.0 amps, -12.0V, ±10% at 1.6 amps and -5.0V, ±5% at 5.0 amps. The in-60A is a 10 inch by 12 inch memory card and available from stock.

Circle #107 on Readers Service Card

Steer Laser Beam

The Ealing Corporation, Optics Division, has announced the availability of a pin mounted beam steering device that is capable of offsetting a laser beam 12 inches and rotating it horizontally up to 330°. The device provides a means of raising a laser beam from a low table mounted laser up to a higher optical axis. Useful for large heavy laser sources that cannot be conveniently mounted in alignment with the optical axis. Device is equipped with two 30mm square aluminized silicon monoxide-coated mirrors; each is separately mounted on a carriage that allows the mirrors to be aligned on three axes.

The top carriage permits horizontal beam rotation up to 330°. The maximum height of the exit beam above the base is 12 inches; the minimum entrance beam height is 2 1/2 inches above the base. The bottom mirror may also be adjusted to accommodate non-parallel incident beams.

Circle #108 on Readers Service Card

Non-glare Screen



SGL Homalite, a Division of SGL Industries, Inc., has a new non-glare screen which it says "effectively improves the readability and definition of LED's, Incandescents and Crystal Displays." The abrasion resistant, water clear thermosetting plastic achieves its non-glare characteristics through basic design and formulation, maker says, eliminating need for vacuum deposition, laminations, or coatings.

Circle #109 on Readers Service Card

Transducers

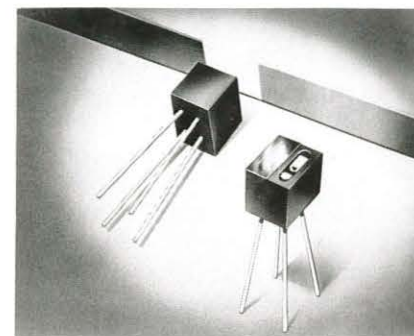

New series of fast, highly sensitive OPTO-PAIR reflective transducers which combine an emitter and detector in a single compact package also incorporate an infrared, bandpass filter over the phototransistor detector to assure operation within specifications under adverse ambient conditions caused by stray fluorescent or other short wave-length lights. Available from Sensor Technology, Inc., Chatsworth, California, the transducers have been specially designed for beginning/end-of-tape sensing, character recognition, mark sensing, optical ignition and similar applications.

Designated STRT-850/F, STRT-850A/F, and STRT-850B/F, the units combine a high-output gallium arsenide infra-red emitting diode (L.E.D.) and a sensitive silicon NPN phototransistor chip, with the emitter and detector elements both positioned on the same perpendicular plane, thus ensuring response to radiation only when a reflective surface comes into the field of view of the phototransistor.

Circle #110 on Readers Service Card

Illume Meter

Photo Research has illustrated literature describing new two-module, cosine-corrected Spectra® "Micro-Candela" Illumination Meter, available with analog meter (Meter A) or non-blinking digital readout (Model D). "Extremely sensitive" photo-multiplier unit is said to accurately measure illuminance within a range of 0.00001 (10⁻⁵) to 0.001 (10⁻²) foot-candles, with spectral response matched to that of human eye.

Circle #111 on Readers Service Card

Hi-Pure Crystals

Interactive Radiation, Inc. announces availability of high purity single crystals of triglycine sulfate, L-alanine doped triglycine sulfate and triglycine fluoroberylate. Crystals can be supplied as blanks or as plates cut and polished to specifications. Unsupported polished windows as thin as 30 microns are available. All three crystal types are said to have good pyroelectric properties, are being used in infrared detectors and detector arrays and in infrared vidicons. Technical literature sent on request.

Circle #112 on Readers Service Card

New LED Digit

Industrial controls, instrumentation, and point of sale systems such as electronic cash registers and scales requiring clear reading for distances up to 20 feet are said to be applications for Litronix's new, low-cost 0.6" high LED digit. The Data-Lit 747 is called ideal for these applications because its mitered-corner, light pipe design provides a broad segment width for easy viewing and high readability.

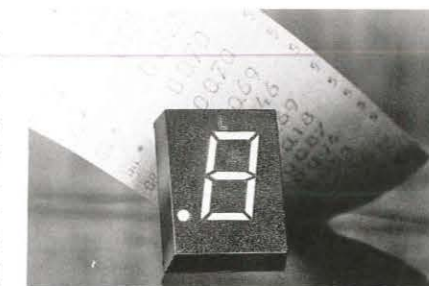

The DL-747 is a common anode, left decimal point digit with standard double DIP pin spacing. Brightness is specified at 5mcd @ 20mA. The new digit is the second of Litronix's second-generation displays constructed with its ELD (Encapsulated Light Diffusion) light pipe technique. The 0.3" DL-707 was the first digit introduced with this process.

Circle #113 on Readers Service Card

Please Pass the SID

We'd like this issue of SID JOURNAL to get as wide circulation as possible. So, let your co-workers, maybe even your boss, read this issue.



8-Digit Display

New eight-digit display for use with single pan balances offers automatic pushbutton zero, automatic pushbutton ranging, and serial BCD output for connection to a printer, tape punch, computer or other data recording and storage devices.

On the Model D-15, as it is designated by its manufacturer, Volland Corporation, the last three digits represent the on-scale range. They are operated by an output in the range of 0 to 1 volt from a transducer on the beam of the balance.

The operator selects each of the other digits individually by switches mounted on the weight-changing dials of the balance.

The automatic zero pushbutton makes it easy to zero the balance. With all weight knobs at zero and the pan empty, the operator pushes the button. The current output from the transducer on the beam of the balance at the instant the button is pushed becomes "zero by definition" and all digits on the Model D-15's display will read zero. Further readings of the balance are based on this value.

Circle #114 on Readers Service Card

Troubleshooter

Troubleshooting digital equipment in the engineering lab, on production line or in field service is called simple and easy using new technique of capturing any section of a digital bit stream. New Hewlett-Packard Application Note 167-1, "The Logic Analyzer" describes in detail how method is used with the Hewlett-Packard Model 5000A Logic Analyzer.

Circle #115 on Readers Service Card

Oscilloscope

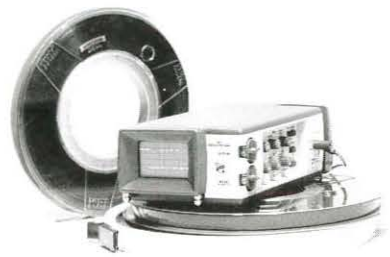

A 3.5-pound portable oscilloscope with 5 MHz of bandwidth, 5 mV/division of sensitivity and 1 μ second/division sweep speed has been announced by Tektronix, Inc. Designated the 221, small size and "versatile" measurement range are termed well suited to problems of computer maintenance and troubleshooting.

Within an overall package of 3 inches x 5.2 inches x 9 inches, the 221 contains a rechargeable battery that will recharge itself while operating on line power. Without internal or external switching, the miniscope can be powered by 50 to 60 Hz AC or DC from 90 to 250 volts.

Operator conveniences designed to reduce set-up time and make the display easier to interpret include: (1) an integral 1 M Ω probe which is always there and ready to use; (2) easy-to-read deflection factors; (3) trigger level and slope simplified in one rotary control; (4) AUTO trigger mode with a bright reference trace.

Circle #116 on Readers Service Card

Hi-Visi Meters

To provide improved visibility of tank level indications, Metri-tape, Inc. (Concord, Mass.) is offering NEMA-style panel boxes with round high-visibility meters having full 9" scale length. High-visibility meter indicators are offered in shared, multi-channel configurations, utilizing rotary channel selectors, and in multiple-meter arrays for graphic marine and industrial tank farm displays. Meters can be custom-calibrated to show English or metric material level measurements.

Circle #117 on Readers Service Card

LA-SID Views LED Results

Results of a research and development program to develop a matrix display using doubly-doped LEDs capable of emitting red, amber and green light from a single die were presented at a recent meeting of the Los Angeles Chapter of SID, held at Litton Data Systems, Van Nuys, Cal. Ronald Shattuck and George Kaelin conducted the presentation.

LEDs are packed over 20 to the inch, resulting in an overall density of over 400 per square inch. The



Ronald Shattuck demonstrated the 4x4' mockup that accurately and dynamically simulated the appearance and operation of the multi-color LED display. The LED display program is supported by the Communications and Automatic Data Processing Laboratory of the U.S. Army Electronics Command. The technical direction for this military program is under Peirce Siglin (Fellow SID) and E. Kral.

LEDs are so bright that in a command and control situation they can be used to shine right through a printed map containing geographical detail. Various hybrid circuits are packaged behind the LED matrix, providing local memory and support electronics for a hybrid display module. These modules, approximately one square inch in size, are then stacked to form an uninterrupted matrix display of any size, with a depth no greater than 4 1/2". A mock-up of such a 4x4' display was shown.

It is obvious, the speakers pointed out, that there could be many applications; and that that Holy Grail of display engineers, a flat, large-size, color, real-time display, may be nearer than it may seem.



Los Angeles SID members view demonstration of new LED matrix at Litton Data Systems.

Laser Show, Tokyo

U.S. products in fields of lasers and electro-optical equipment and components dominate the import market in Japan, due to their quality and durability, says the U.S. Department of Commerce. To enable U.S. firms to capitalize on this demand, the Department is sponsoring a show of U.S. products in this field, February 12-16, at the U.S. Trade Center, in Tokyo. Persons interested should contact Maurice Shea, Department of Commerce, BIC-232, Washington, D.C.

Pass SID Journal along to a friend.

SID Issues Call for Papers

Call for papers for the SID 1974 International Symposium has been issued. Abstracts and draft-summaries are due January 14, 1974. The Symposium will be held at San Diego (Cal.) May 21-23, 1974.

The SID Symposium, described as "The only annual global forum devoted exclusively to all aspects of information display," invites original papers describing significant developments, not previously published or presented, in display hardware and software techniques, devices, systems, applications and effectiveness.

Areas of Interest

Areas of interest include, but are not restricted to: flat-panel displays; large area displays; color displays; matrix displays; raster-scan displays; command and control displays; inter-active displays; image storage and retrieval.

Hard copy displays; laser displays and holography; human factors and perception; computer graphics; information display systems; new display techniques and devices; 3-D displays; display theory; display applications; display standards and measurement; display-oriented software; cost/performance and display economic factors; electronics for displays.

Verne J. Fowler, Program Secretary, says papers should be suitable for a 20-minute presentation, and authors are requested to submit both a 35-word abstract and a 500-word draft-summary. Since papers are selected on the basis of the draft-summary, they must include a concise statement of what new and significant results have been obtained. Hand drawings and sketches should be included to aid in the selection of papers.

The 35-word abstract, suitable for publication in an Advance Program, should be typed on a separate sheet, and include title of talk, author's name, affiliation, complete address and telephone number.

Summaries must be submitted in single-side, black-on-white, double-spaced typewritten form suitable for reproduction and review purposes.

The author's name, affiliation, complete address and telephone number must appear on the first page, with the author's name and abbreviated paper title on each subsequent page. Authors of accepted papers will be asked to prepare a final condensed version for publication in the Symposium DIGEST.

Both the abstract and the draft-summary should be forwarded to Verne J. Fowler, GTE Labs Inc., 40 Sylvan Road, Waltham, Mass. 02154/Tel.: 617-890-8460, Ext. 770, no later than January 14, 1974.

A few post-deadline papers for 10-minute presentation will be considered if 100 word abstracts and 300-500 word summaries, with any pertinent illustrations, suitable for publication, are received by April 19, 1974.

A supplemental program on displays, featuring in-depth tutorials on devices, techniques, and systems, will be cosponsored by SID and the Continuing Education in Engineering, University Extension, and the College of Engineering, University of California, Berkeley, California. Anticipated dates are May 20 and 24.

Computer Increase In US Documented

There were 100,420 computers in the U.S. in 1972, a 22.5% increase over 1971, according to the Diebold Group, Inc. The largest increase was in the number of minicomputers, over 63%; the minis accounted for 54% of the total, compared with 40% in 1971. For the first time since Diebold published its computer census, there was a decline in the number of installed computers other than minis.

Martian Contract

A \$2-million contract has been awarded to Philco-Ford Corporation's Western Development Laboratories (WDL) Division in Palo Alto to build the communications antenna subsystems for the orbiter portion of NASA's Viking '75 spacecraft which will visit Mars in 1976, searching for evidence of Martian life.

Scientific instruments aboard the orbiter will measure both atmospheric and surface parameters for clues to the dynamic characteristics of the planet, and will map the topography of Mars, using both visual and infrared techniques. The orbiter will also transport the lander to Mars and transmit telemetered data from the lander back to Earth.

Litronix Acquires LSI

Litronix, Cupertino, California manufacturer of LED's, has acquired Advanced LSI Technology, Inc. of Sunnyvale, California. The acquisition increases Litronix' penetration into the MOS business. Advanced LSI, active in MOS wafer fabrication and ion implantation will continue.

Following table shows estimated number of systems in each size category:

Computer Size	Number Installed	
	1971	1972
Minicomputer	33,020	53,895
Small	36,600	29,300
Medium	10,600	14,900
Large	1,700	2,400
TOTALS	82,000	100,400

Estimated total installations of major manufacturers:

	1971	1972
IBM	38,300	41,400
Digital Equipment	11,700	14,500
Honeywell	5,900	6,700
Univac	4,700	7,500
NCR	3,800	3,600
Burroughs	2,070	2,090
Control Data	1,900	1,700

If You Heard 'Em Lucky, If You Didn't, Too Bad

The following chapters of the Society for Information Display have conducted meetings with the subject matter shown, in the recent past — Editor.

NEW ENGLAND

September 18, 1973

Speaker: Donald L. Say, CRT Engineering Section Head, GTE Sylva, Inc.

Topic: High-Resolution Two-Color Shadow-Mask CRT. (For extensive treatment of subject-matter, see article in SID Journal, November/December, 1972 — EDITOR).

MINNEAPOLIS/ST. PAUL

October 19, 1973

Speaker: William McEwen, Product Line Manager, Data 100 Corp.

Topic: Remote Batch Terminal System.

SAN FRANCISCO BAY AREA

September 25, 1973

Presiding: Tim Thompson, Chapter Chairman

Topic: Tour of Almaden AF Radar Station

LOS ANGELES

October 24, 1973

Speakers: Gary Harris; Bill Smith; Chuck Wallace; Joe Wallin; all of Xerox Corp.

Topic: Xerox and Interactive Graphics, plus demonstration of Xerox interactive graphic system and software.

November 27, 1973

Speaker: Dick Winner, Manager, Advanced Controls and Displays, Hughes Aircraft Co.

Topic: High Visibility Miniaturized Avionics Displays (method for utilizing miniaturized cathode ray tubes in conjunction with suitable magnifying optics to provide an avionics display within the flight helmet).

SAN DIEGO

November 6, 1973

Speaker: Ron Rudolph and Arlen Donner, both of FAA.

Topic: Mr. Rudolph spoke on radar and displays; Mr. Donner, data systems specialist and air traffic controller, spoke on software which stores flight plans, tags radar returns with aircraft identification, altitude and ground speed. A tour of Miramar Naval Air Station followed the talks.

DELAWARE VALLEY

November 15, 1973

Speaker: Dr. Nabil Farhat, of the Electro-Optical Labs, University of Pennsylvania.

Topic: Microwave Holography, with demonstrations of Lasers, Holograms and Sensors.

SID Sustaining Members

ALLGEMEINE ELEKTRICITÄTS—
GESELLSCHAFT
AEG-Telefunken
Vorstandssekretariat
6 Frankfurt/Main-Süd
West Germany
AEG Hochhaus

BURROUGHS CORPORATION
Defense, Space & Special Systems
Group
Paoli, Pennsylvania

CHERRY ELECTRICAL PRODUCTS
CORP.
3600 Sunset Avenue
Waukegan, Illinois 60085

CONRAC CORPORATION
330 Madison Avenue
New York, New York 10017

DIACON, INC.
4812 Kearny Mesa Road
San Diego, California 92111

DuMONT ELECTRON TUBES
AND DEVICES CORPORATION
750 Bloomfield Avenue
Clifton, New Jersey 07015

FERRANTI ELECTRIC COMPANY
Plainview, New York

GML CORPORATION
594 Marrett Road
Lexington, Massachusetts 02173

HUGHES AIRCRAFT COMPANY
Culver City, California 90230

IBM CORPORATION
Armonk, New York

PHOTO RESEARCH DIVISION
KOLLMORGEN CORPORATION
3000 N. Hollywood Way
Burbank, California 91505

NAC INCORPORATED
17 Kowa Bldg., No. 2-7
Nishiazabu 1-Chome
Minato-ku, Tokyo, Japan

PHILCO-FORD CORPORATION
Palo Alto, California

ELECTRONIC SYSTEMS DIVISION
RANK PRECISION INDUSTRIES
LTD.
Sidecup-by-Pass
Sidecup, Kent, England

SIEMENS AG
Components Marketing
76 St. Martinstr.
Munich, West Germany

SINGER-LIBRASCOPE
Aerospace & Marine Systems Group
933 Sonora Avenue
Glendale, California 91201

SYNTRONIC INSTRUMENTS, INC.
100 Industrial Road
Addison, Illinois

TEKTRONIX, INC.
Information Display Products
P.O. Box 500
Beaverton, Oregon 97005

THOMAS ELECTRONICS, INC.
100 Riverview Drive
Wayne, New Jersey 07470

THOMSON-CSF
Paris, France

DEPARTMENT OF SUPPLY
WEAPONS RESEARCH
ESTABLISHMENT
Salisbury, South Australia 5108

XEROX DATA SYSTEMS
El Segundo, California 90245

Cash Awards for Computer Papers

Cash awards of \$50 each are announced for up to 24 individuals whose papers are selected for presentation at the June 20, 1974, Symposium of the Assn. for Computing Machinery. In addition, first and second prizes of \$250 and \$200 will be awarded. Objective is to emphasize computer applications, data automation systems, and information systems that are installed and working with a reasonable degree of success. February 15 is the deadline for 150-word abstracts and full drafts of 2,500 words or less, to Mrs. Zella Ruthberg, Rm. B255 Technology Bldg., National Bureau of Standards, Washington, DC 20234. Symposium will be held at Gaithersburg, Md.

Advertisers Index

Optical Coating Laboratory, Inc.	32
Photo Research Corporation	4
RCA Electronic Components	31
SC Electronics	13
Special Purpose Technology Co.	8
Syntronic Instruments	2

COM comes cleaner

with RCA ultra-high resolution CRT's...

Because RCA specifically designs, develops and builds these precision CRT's—from phosphor to electron gun—for Computer Output on Microfilm applications. RCA types like the five-inch C24125 and the seven-inch 4506 can achieve ultra-high resolution with a line width less than 0.0009 inch between the 50% points on the line profile.

The phosphor RCA produces for these tubes is responsible for much of their outstanding performance. It has a spectral distribution that achieves excellent energy coupling to ultra-fine-grain photographic emulsions. And it is applied to the faceplate by special techniques that assure particle sizes

compatible with the ultra-fine electron beam spot created by the electron gun. The result is a highly uniform phosphor screen free from mottling and other defects that interfere with high quality recording.

There are many more reasons why RCA ultra-high resolution CRT's perform so well in COM and other photographic reproduction applications. Your RCA Representative will be glad to give you more information on them. See him today or contact: Manager, Market Planning, Display Tube Products, Section ZD8, RCA, New Holland Ave., Lancaster, Pa. 17604. Telephone (717) 397-7661 TWX 717-560-4403.

RCA Electro Optics

INTERNATIONAL SALES OFFICES: ARGENTINA—Casilla de Correo 4400, Buenos Aires/BRAZIL—Caixa Postal 8460, São Paulo/CANADA—21001 No. Service Rd., Ste. Anne de Bellevue, 810 Quebec/ENGLAND—Sunbury-on-Thames, Middlesex/HONG KONG—P.O. Box 112/MEXICO—Apartado 17-570, Mexico 17, D.F./SWITZERLAND—118 rue de Rhone CH1204, Geneva